

# Wireless World

RADIO AND ELECTRONICS

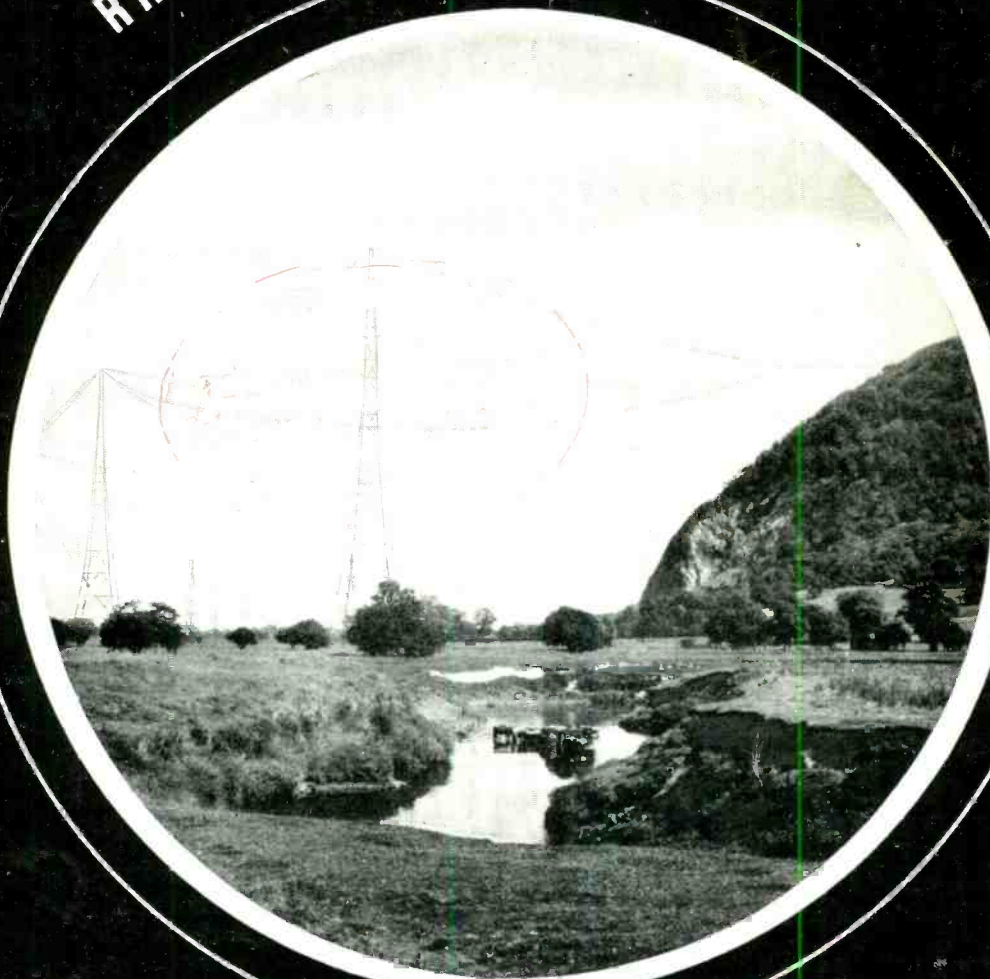

MAY 1947

1/6

Vol. LIII, No. 5

IN THIS  
ISSUE :

DEVELOPMENTS IN COMMUNICATIONS

**RADIO**  
**INDUSTRY**

*prefers*

**B.I.**  
*Callender's*

**PRODUCTS**

Our products for the Radio Industry range from the tallest steel radio towers to 0.001  $\mu$ F capacitors. If you're not interested in monsters or midgets we make a lot of other things besides, including every type of cable and wire used in radio work. You get the benefit of 60 odd years research and manufacturing experience when you specify B.I. Callender's.

**BRITISH INSULATED CALLENDER'S CABLES LIMITED**  
NORFOLK HOUSE, NORFOLK STREET, LONDON W.C.2



REGD. TRADE MARK

MODEL 7  
UNIVERSAL  
AVOMETER

MODEL 40  
UNIVERSAL  
AVOMETER

THE AVO  
TEST  
BRIDGE

THE "AVO"  
VALVE TESTER

THE  
ALL WAVE  
"AVO" OSCILLATOR

**R**AUDIO manufacturers, service engineers, workshops and laboratory technicians are familiar with the precision and dependability of "AVO" Electrical Testing Instruments. Long years of successful experience in the design and manufacture of first-grade instruments have produced a consistently high standard of accuracy which has become a tradition as well as a standard by which other instruments are frequently judged.

**THE AUTOMATIC COIL WINDER & ELECTRICAL EQUIPMENT CO., LTD.**  
 WINDER HOUSE, DOUGLAS STREET, LONDON S.W.1 TELEPHONE: VICTORIA 5404/7



*Main Details of the Range of*  
**CELESTION PERMANENT MAGNET LOUDSPEAKERS**

CHASSIS DIAMETER	MODEL	SPEECH COIL IMPEDANCE OHMS	POLE DIAMETER	FLUX DENSITY GAUSS	TOTAL GAP	PEAK HANDLING CAPACITY
2½"	P2V	3.0	7/16"	8,500	8,000	¼W
3½"	P3C	3.0	¾"	7,700	24,000	1W
5"	P5Q	3.0	¾"	8,500	26,000	2W
	P5T	3.0		10,500	32,000	2W
6½"	P6Q	3.0	¾"	8,500	26,000	3W
	P6T	3.0		10,500	32,000	3W
8"	P8D	2.3	1"	6,200	24,000	4W
	P8M	2.3		8,000	31,000	4W
	P8G	2.3		10,000	39,000	4W
10"	P10M	2.3	1"	8,000	31,000	6W
	P10G	2.3		10,000	39,000	7W
12"	P64	15.0	1½"	12,500	140,000	12W
18"	P84	10.0	2½"	13,500	350,000	40W

FROM the range of Celestion Loudspeakers most manufacturers are able to meet their requirements. The smallest model, a midget weighing 3½ oz. is intended for small personal radios and the largest, capable of handling 40 watts, for public address purposes. Between these extremes, the range is balanced and well considered.

**PUBLIC SALES**

Several Loudspeakers of this range are available to the public in chassis form or housed in attractive cabinets. All enquiries for these must be directed to our sole wholesale and retail distributors, Cyril French Ltd.

**SOLE DISTRIBUTORS**  
to the Wholesale and Retail Trades:  
**CYRIL FRENCH LTD.**  
29 High Street, Hampton Wick,  
Middlesex. KINGSTON 2240

**CELESTION LTD., KINGSTON-ON-THAMES SURREY PHONE: KINGSTON 5636-7-8-9**

**AMBASSADOR**



**RADIO**

AMBASSADOR were one of a select few Manufacturers chosen for the quality of their Radio to exhibit at the BRITAIN CAN MAKE IT EXHIBITION. It is not surprising AMBASSADOR RADIOS sell as fast as they can be made. Write for Brochure to:  
**AMBASSADOR RADIO WORKS**  
HUTCHINSON LANE,  
BRIGHOUSE,  
YORKS.

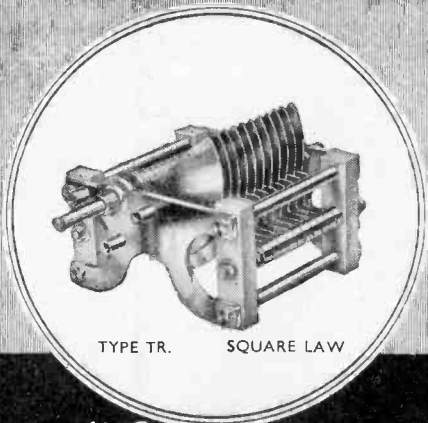

TYPE TR. SQUARE LAW

*"Cyldon"*  
**TRANSMITTING Capacitors**

**SYDNEY S. BIRD & SONS, LTD.**  
CAMBRIDGE ARTERIAL ROAD, ENFIELD, MIDDX.  
'Phone : Enfield 2071/2. 'Grams : "Capacity, Enfield."

# POINTERS FOR DESIGNERS

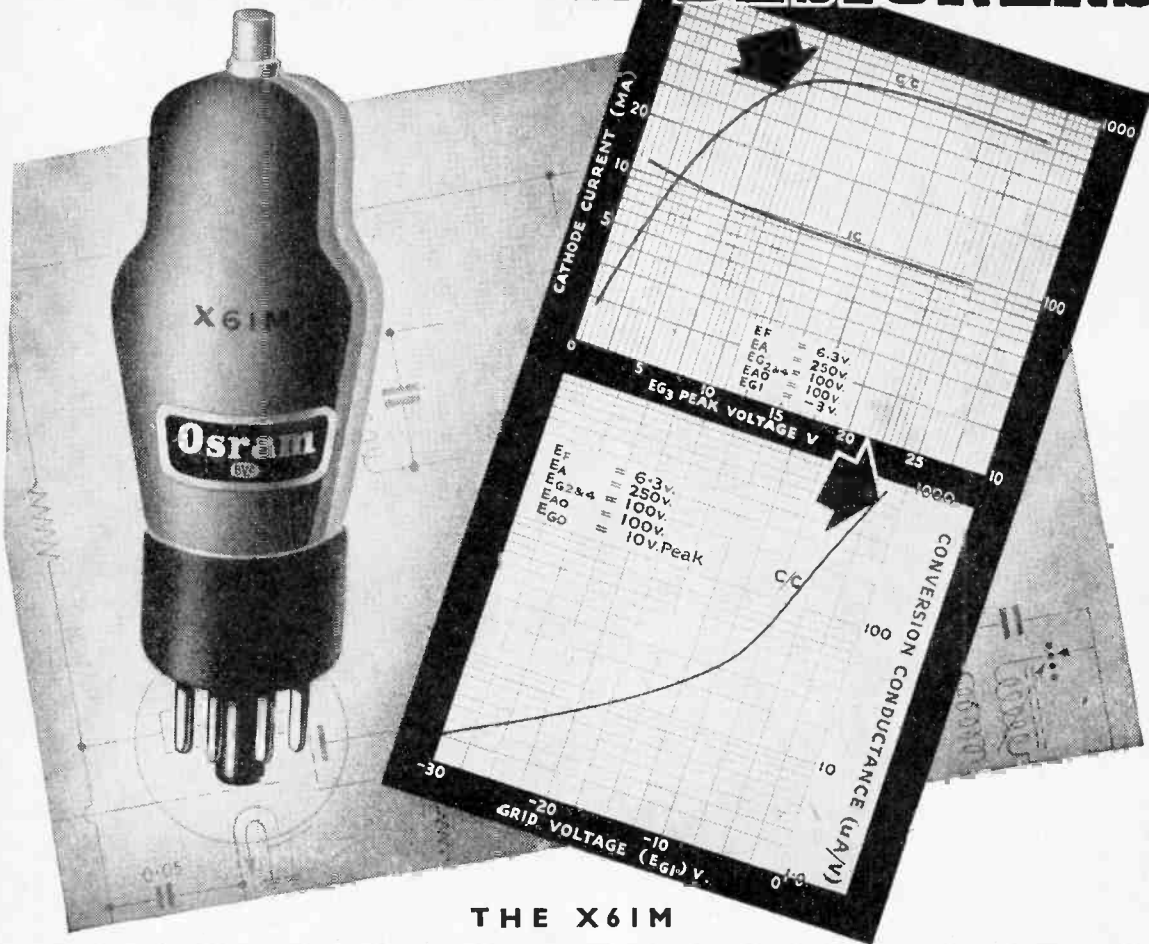

**THE X61M**

An indirectly heated 6.3v. frequency changer of the Triode-Hexode type, the OSRAM X61M is suitable for operation up to 60 megacycles per sec. (5 metres). Outstanding features include:—

- High conversion conductance for comparatively low cathode current, improving signal to noise ratio.
- Signal handling capacity is such that negligible distortion is apparent up to 5 volts R.M.S. on the signal grid.
- Negligible "pulling" when tuned anode oscillator is used, making ganging of tuned circuits easy.
- Control characteristic is designed to work in combination with KTW61 as IF amplifier, giving maximum control on both valves with negligible distortion.

A detailed technical data sheet is available on request.

**Osram**  
PHOTO CELLS

**G.E.C.**  
CATHODE RAY TUBES

**Osram**  
VALVES

Adv. of The General Electric Co. Ltd., Magnet House, Kingsway, London, W.C.2.

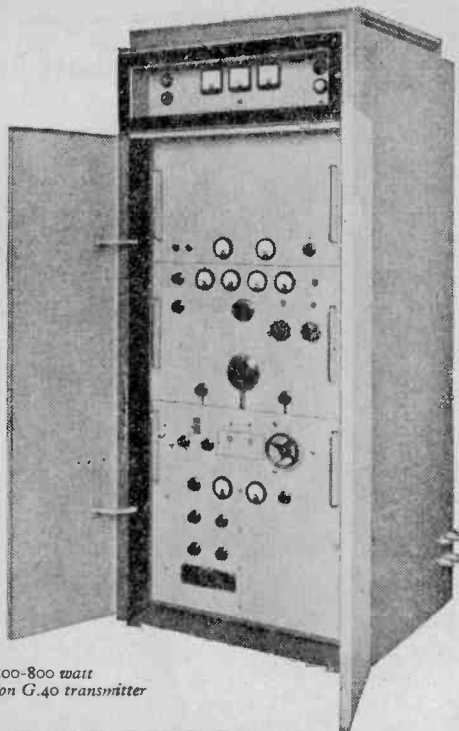

The 500-800 watt  
Redifon G.40 transmitter

## REDIFON G.40

### A new transmitter of exceptional adaptability

**T**HE Redifon G.40 transmitter is a post-war design available with alternative R.F. and Modulator units, enabling the user to select exactly those services which fit each individual requirement. Maximum output power is over 800 watts on C.W., or 500 watts for Telephony or M.C.W.

In its simplest form, the Redifon G.40 is a C.W. transmitter for medium or shortwave communication. A frequency range of 137 Kc/s to 25 Mc/s is covered by 4 alternative R.F. units, any two of which can be fitted into one set, operating simultaneously or on instantaneous switch-over.

As a telephony station, the G.40 can be fitted with one R.F. unit and a Modulator to give 500 watts for broadcast or communication purposes.

The G.40 is ideal for medium-sized airports, where an M.F., C.W. beacon is required for navigation, and S.W. telephony for ground-to-plane communication. For this role a special model is available with a 500-watt telegraphy channel and an independent 250-watt telephony service.

For full details of the Redifon G.40 write to our Communications Sales Division.

## Rediffusion Ltd.

Designers and Manufacturers of Radio Communication  
and Industrial Electronic Equipment

BROOMHILL ROAD, LONDON, S.W.18

# BSR

SOUND SYSTEMS AT THE

# BIF

STAND No. C.1517, OLYMPIA HALL, LONDON

### DISC RECORDING

We shall be demonstrating our new Disc Recorder and Recording Amplifier at the BIF, and the entire range of BSR sound equipments, which will include many new features, will be available for your inspection.

Home Trade and Overseas Visitors are cordially invited to our exhibit and well-informed people will make the BSR stand their rendezvous—a wise move towards "Sound Understanding."



**BIRMINGHAM SOUND REPRODUCERS LTD.**

CLAREMONT WORKS, OLD HILL, STAFFS. TEL: CRADLEY HEATH 6212-3  
LONDON OFFICE: 115 GOWER STREET, W.C.1. TEL: EUSTON 7515

M-W.R.R

**5 mmf/ft**

NEW LOW LEVELS in capacity  
and attenuation of CO-AX Cables  
mean new possibilities in electronic  
equipment design both for the  
war effort and for the post-war  
electronic age.

Write for characteristics

**BASICALLY BETTER  
AIR-SPACED**

## CO-AX LOW LOSS CABLES

TRANSRADIO LTD. 16 THE HIGHWAY BEACONSFIELD 4-BUCKS

# SEARCHLIGHT ON *Quality Control*

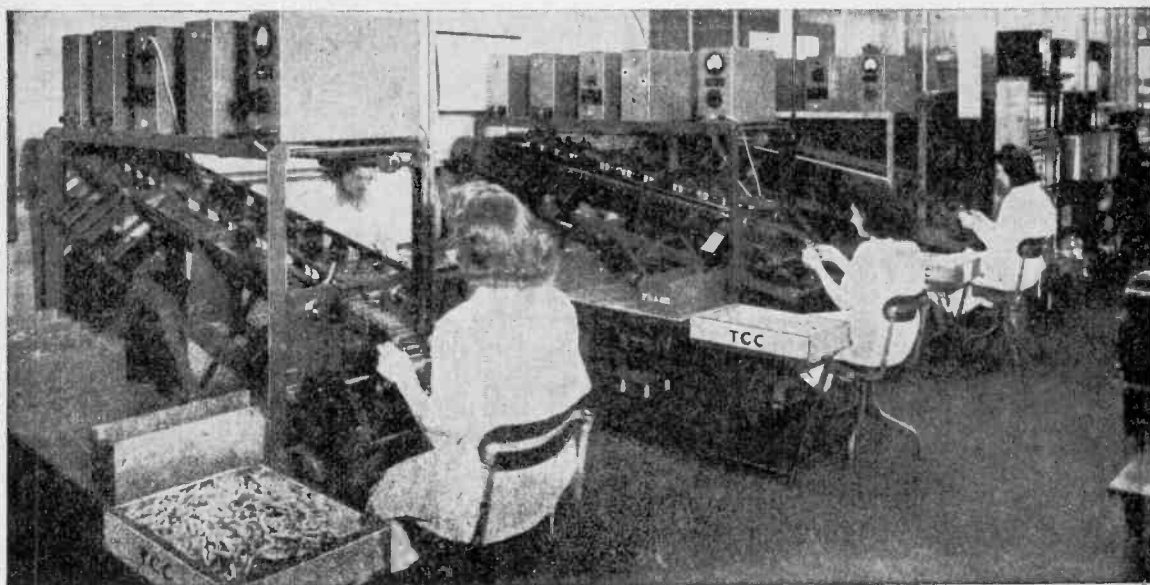

QUALITY Control, in its broadest and widest application, is a never-relaxed feature of every stage in the production of T.C.C. Capacitors.

From raw-material acceptance to final Capacitor test, a keen-eyed team of technicians and operatives, backed by the most modern test equipment, is engaged in the application of scientifically-based control methods with one purpose in mind, that of maintaining the highest attainable standards of quality.

Periodical examination, by statistical analysis, of the collated data ensures the effective application of the control systems employed.

**TCC**  
Capacitors

**THE TELEGRAPH CONDENSER CO. LTD.**

RADIO DIVISION

NORTH ACTON · LONDON · W · 3

Telephone. ACORN 0061



# Your designs

LET US BRING THEM TO

# LIFE!

Made in Three Principal Materials

#### FREQUELEX

An Insulating material of Low Di-electric Loss, for Coil Formers, Aerial Insulators, Valve Holders, etc.

#### PERMALEX

A High Permittivity Material. For the construction of Condensers of the smallest possible dimensions.

#### TEMPLEX

A Condenser material of medium permittivity. For the construction of Condensers having a constant capacity at all temperatures.

the most difficult problems solved by . . .



# Bullers

## BULLERS LOW LOSS CERAMICS

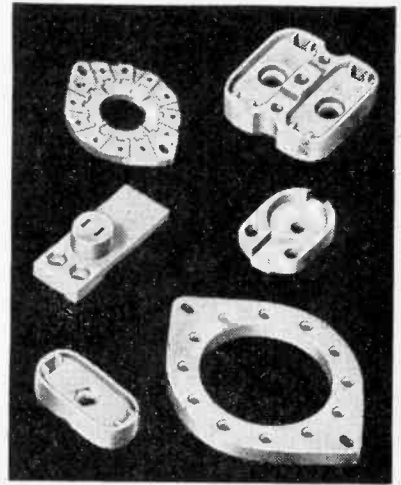

BULLERS LTD., 6, LAURENCE POUNTNEY HILL, LONDON, E.C.4  
Telephone: Mansion House 9971 (3 lines)      Telegrams: "Bullers, Cannon, London"

## A FINE SELECTION OF BARGAINS

**VIBRATOR PACKS**, complete (6in. x 2½in x 5½in.), 6 volts input. output 150 v. at 60 m/A. 25/- ea.

**U.H.F. CONVERTERS**, Type 27, 60-80 mcs. R.L. Series Valves. H.F., Osc., Mixer 7.5 mcs. I.F. output. Rewind coils (Osc. coil 6 turns, aerial and mixer coils 7 turns) and these Converters cover 5 metre band. Performance is remarkable, and this is one of the best Converters available to-day. Power requirements 6 v. and 200/250 volts. A few Type 26 as above, but covering 50-60 mcs. We will supply Type 27 against orders when these are out of stock. £5 ea.  
**Type 25 Converters** using SP41 Valves. 30/40 mcs. Construction and circuit as above units. At present pre-set utilizing 5 position Ceramic Yaxley Switch. Removing this and substituting 3 ganging type 15 pf Tuning Condensers makes an ideal Converter for 10 metres. £4 ea.

**2 VALVE AMPLIFIERS**. (2 volt triode and Q.P.P. Valves.) For adding to TR9 Tx and Rx or many other useful applications. Compact (4½in. x 5in. x 7in.). £11/5/- ea.

**DIALS**. Epicyclic Slow Motion Dials with 3in. ivorine scale. 40-1 reduction (by well known maker). 7/6 ea.

**M.C.R.I. MINIATURE COMMUNICATIONS Rx 5 VALVE SUPERHET** (1R5 Mixer, 1T4 Oscillator, 1T4 I.F. amp., 1T4 2nd Det. and 1T4 L.F. amp.) Four ranges (4 Plug-in Coil Units). Range 1: 100 kc's to 1,600 kc's. Range 2: 2.5 mc/s to 5.0 mc/s. Range 3: 4.5 mc/s to 8.0 mc/s. Range 4: 8.0 mc/s to 15.0 mc/s.  
These Rx are a beautiful job and cost many times our price to produce. As a standby Rx or portable for field days and mobile working they represent one of the finest investments you can make. These are all brand new, unused, and in maker's carton. The price? Only £10/10/- complete.

FULL DETAILS of above are given in our List No. 4 Free on request.

Other offers include :-

**RADIOMART** MICROPHONES, THERMO AMMETERS,  
YAXLEY TYPE SWITCHES, ETC.

Send for List No. 4.

48 HOLLOWAY HEAD, BIRMINGHAM, 1

## Choose your Extension Speaker

FROM THE

# Stentorian RANGE

Prices from 39/6

SENIOR MODEL	£	s.	d.
Type SC with Universal Transformer	5	15	6
" SX minus " "	5	2	6
JUNIOR MODEL			
Type JC with Universal Transformer	5	0	0
" JX minus " "	4	10	6
BABY MODEL			
Type BC with Universal Transformer	2	19	6
" BX minus " "	2	13	6
MINOR MODEL			
Type MC with Universal Transformer	2	5	6
" MX minus " "	1	19	6

# Stentorian

THE PERFECT EXTRA SPEAKER  
FOR ANY SET

WHITELEY ELECTRICAL RADIO CO. LTD.  
MANSFIELD, NOTTS.



# KING OF THE SET



# MAZDA

RADIO VALVES AND CATHODE RAY TUBES

THE EDISON SWAN ELECTRIC CO. LTD.  155 CHARING CROSS RD., LONDON W.C.2

(R.M.42)



CLEAR AS  
THE BELL OF  
BIG BEN  
WHEN YOU'RE  
USING

**Exide**  
L.T. ACCUMULATORS  
AND  
**Drydex**  
H.T. BATTERIES

*The perfect pair for  
battery Radio sets*

THE CHLORIDE ELECTRICAL STORAGE CO. LTD.,  
CLIFTON JUNCTION, NR. MANCHESTER

BDX3D

**SWITCHES ARE  
CONDEMNED**

to  
**Hard Labour  
for Life —**



**OAK EXCLUSIVE  
DOUBLE CONTACT  
SELF-ALIGNMENT  
ENSURE RELIABILITY**



**OAK**  
SWITCHES

★ Only genuine when  
bearing these Patent Nos:—  
478391, 478392

Head Office & Export Sales:

**BRITISH N.S.F. CO. LTD.**, Keighley, Yorkshire  
(Sole Licensees of OAK Manufacturing Co., Chicago)  
London Office: 9 Stratford Place, W.1. Phone: MAYfair 4234  
(Sub-Licensees—A. B. Metal Products Ltd.)

**SENSITIVE VALVE**  
*Voltmeter*

**PRINCIPAL  
FEATURES**

**VOLTAGE RANGE**  
1 mV to 100 volts.

**FREQUENCY  
RANGE**  
50 c/s to 250 kc/s.

**ACCURACY**  
±5% of the actual  
reading.

**INPUT  
IMPEDANCE**  
2 megohms.

**ZERO SETTING**  
Stable and remains  
set on all ranges.

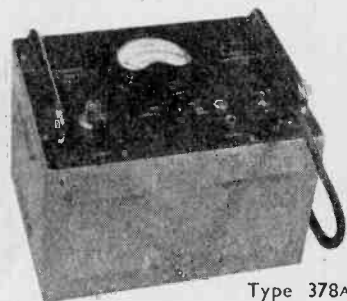

Type 378A

This instrument is now  
available from stock. Write  
for full particulars and  
specification. **PRICE £75**

**FHL FURZEHILL LABORATORIES LTD**  
TELEPHONE BOREHAM WOOD  
ELSTREE HERTS  
1137

# METALLISED CERAMICS

Two new S.P. metallised bushes—  
one at either end of  
the range

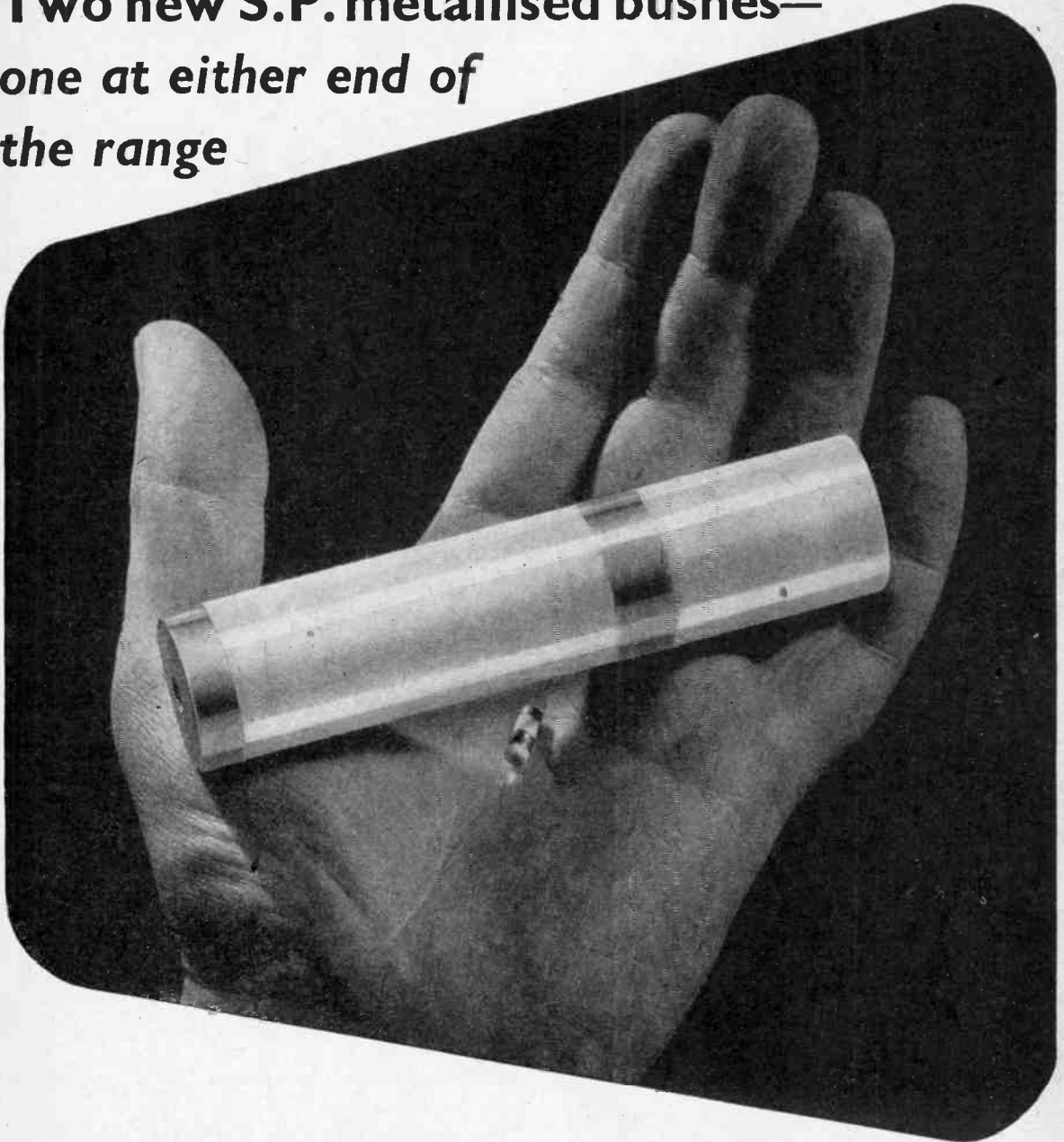

For full information and prices please write to:

**STEATITE & PORCELAIN PRODUCTS LTD.**

STOURPORT-ON-SEVERN, WORCS. Telephone: Stourport III. Telegrams: Steatins, Stourport.



SP-42



The **PIFCO**  
ALL-IN-ONE  
**RADIOMETER**

*tests everything electrical*  
**RADIO, HOUSEHOLD APPLIANCES  
& MOTOR CAR LIGHTING ETC!**

**25/-**

Ask your local Factor to show you one of these remarkable instruments and to put your name down on his waiting list.

**Transformers  
made to suit  
you.**

If your product works on a voltage that the mains does not supply, we can design and build transformers to suit your exact requirements. We manufacture transformers of all types up to 5kVA and we specialise in "Specials" for industrial purposes.

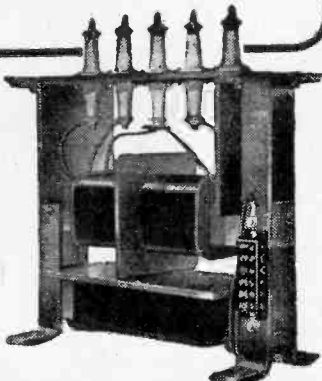

**"PURPOSE-BUILT"**  
**Savage**  
**TRANSFORMERS LTD.**  
51 NORTHGATE STREET, DEVIZES. Phone 536

**DENCO COMPONENTS**

Now available from the following approved Stockists who are qualified to give you good service

- |  |   |
|--|---|
| <b>BATH</b><br>L. F. Hanney                | <b>HARROW</b><br>Odeon Radio              |
| <b>BOSTON</b><br>Vamplew Bros.             | <b>HASTINGS (Ore)</b><br>Service Radio    |
| <b>BRADFORD</b><br>J. Dobson               | <b>HIGH WYCOMBE</b><br>Ryan Bros.         |
| <b>BRIGHTON</b><br>Goodsell, Ltd.          | <b>KINGSTON</b><br>Kingston Radio S. & S. |
| <b>BRISTOL</b><br>Cranbrook Radio          | <b>LEEDS</b><br>Vallance & Davison        |
| <b>BROMLEY, KENT</b><br>R. A. Minter,      | <b>LONDON</b><br>Premier Radio            |
| <b>BURNLEY</b><br>J. Dobson,               | Webbs Radio                               |
| <b>CAMBRIDGE</b><br>Baily, Grundy, & B.    | <b>LOWESTOFT</b><br>N. J. Brundle         |
| <b>CHADWELL HEATH</b><br>Drury, Beardow    | <b>NEWCASTLE</b><br>N. F. Whatley         |
| <b>COLCHESTER</b><br>Joslins, Ltd.         | <b>NORHAM-ON-TWEED</b><br>O. C. Doley     |
| <b>CONWAY</b><br>J. W. B. Evans            | <b>NOTTINGHAM</b><br>University Radio     |
| <b>CORNWALL</b><br>St. Columb Radio        | <b>ORMSKIRK</b><br>Coughlone Radio        |
| <b>COVENTRY</b><br>L. & K. George          | <b>RUGBY</b><br>Benn Radio & Elec.        |
| <b>DARLINGTON</b><br>C.R.S.S.              | <b>SALISBURY</b><br>Southern Radio        |
| <b>ELGIN</b><br>Sam Murphy                 | <b>SOUTHAMPTON</b><br>Worboys & Tourtel   |
| <b>FOREST HILL, S.E.23</b><br>E. A. Porrit | <b>SWINDON</b><br>K. L. W. Cook           |
| <b>GILLINGHAM</b><br>Radiovision           | <b>TEIGNMOUTH</b><br>South Devon A.S.     |
| <b>GLASGOW</b><br>Radiographic             | <b>WORTHING</b><br>Bowers & Wilkins       |
| Clydesdale Supply Co.                      |   |

**DENCO (GLACTON) LTD., GLACTON, ESSEX**

We don't  
stock  
cigarettes!



# MIDGET Components

for  
THE DESIGN OF  
Compact  
APPARATUS

- EDDYSTONE 595, 2in. dial (direct drive) ... .. 5s. 6d.
- 597, 2in. dial (precision slow motion) ... .. 11s. 6d.
- P.R.S. MIDGETRON VALVES, length 43 mm.
- Type 501, L.F. Pentode, filament 1.4 volts at 50 milliamps.
- Type 500, H.F. Pentode, filament 0.75 volts at 50 milliamps.
- H.T. volts for both: 45 to 67½ volts. Price, each ... .. £1 4s. 4d.
- BRIMAR "PEANUT" 1.4 volt Valves—1R5, 12s. 10d.; 1T4, 11s.; 3S4, 11s.
- "WEARITE" MIDGET INDUCTORS, shielded in round cans, 1½ in. dia., 1⅛ in. high, plus tags.
- Type
- 207 Mic. or output transformers Ratio 1/60, 150 m/a on Pri.
- 210 Ditto " 1/15, 75 m/a on Pri.
- 208 Output transformer " 8/1, 7 m/a on Pri.
- 209 Interval transformer " 1/4.3 1 m/a on Pri.
- 212 Modulation transformer " 1/1, 15 m/a both.
- 213 Choke, 40H, 4 m/a, 4,700 ohms. All types each, 15s. 0d.

- "WEARITE" MIDGET I.F. TRANSFORMERS, size 1½ in. by ½ in., for 460 kc/s, 1.6 mc/s, 4.86, mc/s. each 10s. 6d.
- T.C.C. "MICROPACK" ELECTROLYTICS.
- 25 mfd. 50 v., 1½ in. by ½ in. ... .. 3s. 0d.
- 25 mfd. 25 v. 1½ in. by ½ in. ... .. 2s. 9d.
- 50 mfd. 12 v. 1½ in. by ½ in. ... .. 2s. 9d.
- .01 mfd. 350 v. 1in. by ½ in. ... .. 1s. 0d.
- CELESTION MIDGET LOUDSPEAKER. Outside dimensions, 2½ in. square ... .. £1 7s. 0d.
- EDDYSTONE FLEXIBLE COUPLER. Type 529 for ½ in. spindle, diameter 1½ in. ... .. 2s. 6d.
- Type 550 Midget, for ½ in. spindle, dia. ½ in. ... .. 2s. 3d.
- VALVEHOLDERS.
- Hivac Midget Valveholders, 4 and 5 pin, both "Button" ceramic for 6AK5, 9001, V888, etc. ... .. 1s. 0d.
- Diode type Valveholder ... .. 1s. 0d.

# Webb's

14 SOHO ST., LONDON, W.1. Phone: Gerrard 2089

We usually stock these items, but this advertisement must not be taken to guarantee immediate availability. Supply continuity still leaves a lot to be desired.

Hours of Business: 9 a.m. to 5.30 p.m.  
Sats. 9 a.m. to 1 p.m.

# RADIO



Over prickly pear  
or paddy field or  
pasture-across all the  
trackless wastes of  
the world, you know  
where you are with

# MARCONI

MARCONI'S WIRELESS TELEGRAPH CO. LTD.  
THE MARCONI INTERNATIONAL MARINE  
COMMUNICATION CO. LTD. MARCONI HOUSE,  
CHELMSFORD, ESSEX.



# R & A

*Suppliers of Loud Speakers  
to Britain's foremost  
Radio Manufacturers.*

REPRODUCERS & AMPLIFIERS LTD.  
WOLVERHAMPTON, ENGLAND.

**NEW!!**

**"Q-MAX" V.H.F. CONVERTOR**

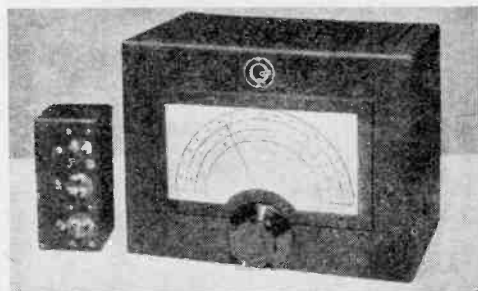

Embodying circuit refinements not found in any other make plus advantages of MONO-UNIT COILS.

Full Vision Calibrated Scale. One knob tuning and Extra Top Coil Range.

PRICE (With 30Mc/s or 56Mc/s Coil Unit) ... **19 Gns.**  
(Extra Coil Units, 30/- each)

Send for illustrated catalogue "W.W."

Obtainable from your local "Q-MAX" Dealer or direct from

## BERRY'S

(SHORT WAVE) LTD

**25, HIGH HOLBORN, LONDON, W.C.1**

(Opposite Chancery Lane)  
Telephone: HOLborn 6231

# DUBILIER PRECISION WIRE WOUND RESISTORS



The remarkable accuracy of the DUBILIER PRECISION WIRE WOUND RESISTOR is due to its scientific construction. A slotted high insulation ceramic former is wound with enamelled resistance wire of not less than 0.0014" diameter. During winding the wire is subjected to tests to eliminate accidentally shorted turns and to ensure the essential high standard of insulation between turns. Contact between resistance element and terminals is by the exclusive DUBILIER moulded metal method which removes the possibility of weak, non positive or noisy connections. All units are suitable for use up to 50 Kc/s. *Full technical details on request.*

DUBILIER CONDENSER CO. (1925) LTD · DUCON WORKS · VICTORIA ROAD · N. ACTON · LONDON · W.3  
 Telephones: ACOrn 2241 (5 lines) Telegrams: Hivoltcon, Phone, London. Cables: Hivoltcon, London. Marconi International Code. D.10

# PERTRIX REDRESSED FOR PEACE

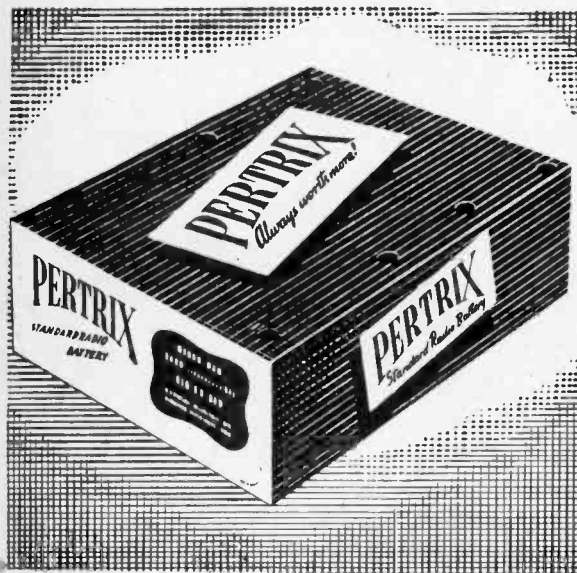

**P**ERTRIX BATTERIES have emerged from the testing ground of war as more reliable, more efficient than ever before. You will soon see them in the smart new post-war pack shown above. It denotes the finest battery for radio use yet made.



**HOLSUN BATTERIES LIMITED**

137 Victoria Street, London, S.W.1.

P.I.A.



When  
**SENSITIVITY**  
is  
**VITAL!**



Type "A"

Details of all types of S. G. Brown headphones priced from 25/- to 105/- are given in Brochure 'W.W.' Free on request.

The enthusiastic radio amateur, experimenter and serviceman using headphones of just average sensitivity should make sure that the next pair they purchase are of the utmost sensitivity as well as capable of giving true quality reproduction.

The famous S. G. Brown Type "A" Headphones give highest possible efficiency; this is attained by the Adjustable Reed Movement which replaces the usual flat diaphragm. When in use, the Reed, in response to the minutest impulses, activates the rigid cone disc which merely sets the air in motion without calling into play any vibratory properties of its own.

Your local dealer can supply  
**S. G. BROWN TYPE "A"**  
**HEADPHONES**  
Price 60/- per pair

'Phone:  
ACOrn  
5021

**S.G. Brown, Ltd.**

VICTORIA ROAD, NORTH ACTON, LONDON, W.3

## Masteradio VIBRATOR PACKS

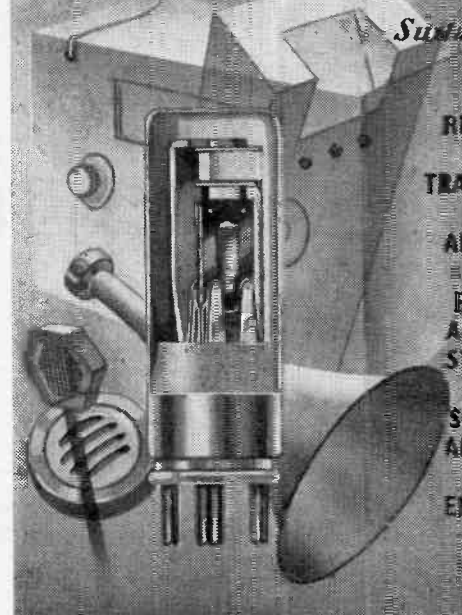

Suitable for

**RADIO  
RECEIVERS  
AND  
TRANSMITTERS**

**AMPLIFIERS**

**PUBLIC  
ADDRESS  
SYSTEMS**

**SCIENTIFIC  
APPARATUS**

**EMERGENCY  
POWER  
SYSTEMS**

MASTERADIO LTD, VIBRANT WORKS, WATFORD, HERTS.



# DELICATE PRECISION BONDING of RUBBER to METAL

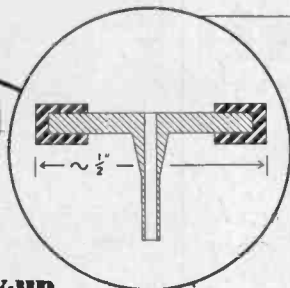
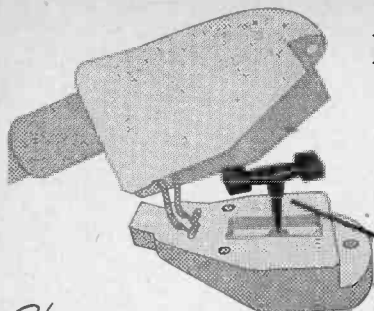

THIS is a particularly interesting example of the science of rubber-bonding to metal. It is the delicate **STYLUS** unit of the new Decca frr pick-up which is carried by two rubber parts, enabling the steel holder with its sapphire point to float and freely transmit to the amplifier of the Decola the full range of frequencies impressed on the record.

Rubber bonded to metal is the answer to a great variety of engineering problems. Have you one for us?

Have you a copy of the new "Short Review"?

The  
**STYLUS UNIT** of the  
**NEW DECCA frr pick-up**  
incorporated in the  
**"DECOLA" de luxe**  
ELECTRIC RECORD REPRODUCER



**RUBBER BONDERS LIMITED**  
ENGINEERS IN RUBBER BONDED TO METAL  
**FLEXILANT WORKS • DUNSTABLE • BEDS.**  
TELEPHONE: DUNSTABLE 80345

Robert Sharp & Partners

RB.62

*For efficient detection and A.V.C.*

**WESTINGHOUSE**  
**WESTECTORS**

WESTINGHOUSE BRAKE & SIGNAL CO. LTD., 82, YORK WAY, LONDON, N.I.

*It's easy to make Pick-ups  
— if you know how.*  
The know-how in the manufacture of  
**Lexington**  
MOVING COIL PICK-UPS

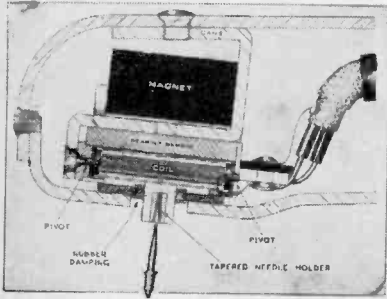

is the result of long experience and precision watch-making standards which give a finely constructed instrument the details of which are shown in the sectional diagram.

**DE LUXE MODEL** • Robust design. Accidental dropping on record will not damage Pick-up • Extremely low moment of inertia (80 milligrams total weight of movement) • Pure sine wave with no harmonic distortion • Automatic needle or sapphire changing opens new fidelity field to the amateur • Can be used with normal record changer without fear of damage.

Price (without sapphire) **£5.10.0**, plus 24/6 P.T.  
Sapphire Needle with specially tapered shank, price 15/3 extra (including P.T.)

**JUNIOR MODEL.** Identical in design and workmanship to the De Luxe, the only difference being that it is not equipped with the Automatic Sapphire needle inserter and Extractor device and metal sole plate. Made to take standard steel and fibre needles this model enables every music lover to enjoy the fine reproduction which only a moving coil pick-up can give. **£3.9.3**, plus 15/5 P.T.

See November issue for Curve of Pick-ups

• **PLUG-IN HEADS** •

These are available in both Junior and De Luxe types to fit Collaro and Garrard arms, thus providing a change-over from Magnetic types. Input conversion may be required. (See our Technical Brochure.) Price 49/6, plus 11/- P.T.



Separate Ejector for De Luxe type, 30/10, plus 6/10 P.T.

• **PRE-AMPLIFIERS** •

having an inverse of the recording characteristic incorporated are available for use with pick-ups. These are necessary with some amplifiers. Price complete with valve and Input Transformer, **£6.1.0**.

Illustrated Technical Brochure upon request.

Export and Trade Enquiries Invited.  
Obtainable through your local dealer.  
PLEASE NOTE NEW ADDRESS:—

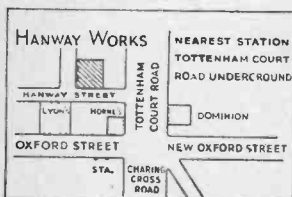

**COOPER**  
MANUFACTURING CO.  
HANWAY WORKS,  
HANWAY ST., LONDON, W.1  
Telephone: MUSeum 9779  
SALES OFFICES—Top Floor

**M.R. SUPPLIES Ltd.**

offer only brand new and guaranteed material, with immediate delivery from stock All prices net.

**EX-ARMY NO. 38 TRANSMITTER/RECEIVERS** (Walkie Talkie). Range up to 10 miles. Wavelength 7.3 to 9 m/c. (approx. 30/40 metres). Compact Infantry type. Items sold separately: Transmitter/Receiver with valves, 55/- (despatch 3/-); Box of 3 spare valves, 17/6; Throat Microphone, 10/-; Headphones with plug, 10/-; Telescopic Aerial in case, 7/8. The complete station (less 120 v. and 2/3 v. battery), **£5** (despatch 5/6).

**"FUZIT" WIRE JOINTERS.** A large purchase enables us to present this opportunity. This very useful R.T.O. product electrically welds all gauges of wire from 30 to 30 a.w.g. (copper and resistance) instantly. No solder or flux, no dry joints. Operation 200/240 v. A.C. Equipment comprises well-housed portable transformer, hand-tool with carbon electrodes and trigger, leads, ready for use. Further details if required, but supply limited. **78/6** complete (des. 2/6).

**MINIATURE COMMUNICATION RECEIVERS (M.C.R.1).** An unbeatable M.R. £17. The 5-valve superhet in metal case approx. 9in. by 3in. by 2in., A.C./D.C. Power Pack in same size case, two H.T./L.T. Batteries (one spare), four coil units, headphones, aerial and earth, complete, universal and mobile, brand new in hermetically sealed container, **£10** (carr. 4/6). (The tuning ranges are: 188/3000 metres, 60/120 metres, 38/67 metres, 20/38 metres.)

**MINIATURE PIEZO-CRYSTAL MICROPHONES** (Rothermel-Brush). Only 1 1/2in diameter, with 5 megohm loading incorporated, made for desk-aids but suitable for all music purposes, **28/6**.

**DIMMERS** for Stage Lighting. Fully enclosed, with slow motion drive and hand-wheel, carbon break flicker-switch, rated to control staled load from full-bright to blackout at 220-240 v. 500 watts, **78/6** (des. 3/6); 1000 watts, **£7/2/6** (des. 4/6); 1500 watts, **£8/12/6** (des. 5/-); 2500 watts, **£9/15/0** (des. 5/-).

**PRECISION VOLTMETERS**, 3 1/2in. flush panel rectified m/coil, 0/250 v. A.C. (in large demand at present for checking mains voltage), **76/6**.

**D.C./A.C. CONVERTERS**, new and vibrator types, for radio, radiograms, television, amplifiers, etc. Silent in operation, fully smoothed output, trouble-free and guaranteed. 200/240 v. D.C. to 200/240 v. A.C. 50 cycles: 200-watt, **£12** (des. 3/-); 100 watts, **£9** (des. 2/-). NOTE: If for television we recommend the 75 cycle model, 200 watts, same price.

**S.T.C. TOGGLE PRESSES**, Senior and Minor models again in stock. Double-acting, space-saving, precise tool suitable for all pressing operations in many trades. Senior, wt. 130 lbs., pressure 1 1/2 tons, **£30**; Minor, wt. 80 lbs., pressure 0.75 ton, **£24/15/0** (prices ex this address).

**I.T. RECTIFIERS** (S.T.C.) for charging up to 12 v., all full-wave: 1.5 amp, **12/6**; 4 amp, **22/6**; 6 to 8 amp, **39/6**. Suitable tapped sec. Mulus Transformers to suit the I.T. a. rect., 22/-; 4 a., **32/6**; 6 a., **51/6**.

**RITARY RESISTORS**, with 2 1/2in. control knob, 3-hole mtg., 4 ohms 4.5 amp, **23/6**; 115 ohms 1 amp, **25/6**; 10 ohms 3 amp, **28/6**, and others.

**ROTHERMEL PIEZO-CRYSTAL PICK-UPS.** Replacement heads for Garrard or Collaro arms. Much improved performance, minimum record wear, 46/11.

**ROTHERMEL SAPPHIRE GRAMO NEEDLES**, the best permanent needle for any pick-up, 12/6 each.

**VORTEXI W. AMPLIFIERS.** Ex stock. The new A.G. Mains/12 v. D.C. 15-watt Power Amplifier. This compact, useful model has inputs for m/c mike, any type pick-up and output matching for 7.5 and 15 ohms, fitted vol. and tone controls, steel housed 18in. by 9in. by 7in., **£28** (des. 5/-).

Please include sufficient for packing and despatch.

**M.R. SUPPLIES Ltd., 68, New Oxford Street, London, W.C.1.**

Telephone: MUSeum 2958

*Miniature or midget*

ACTUAL SIZE

ACTUAL SIZE

30%

24%

10

10

XY 1-4a

XW 8-75A

**HIVAC**

NEW TYPES FOR  
MIDGET RECEIVERS  
HEARING AIDS  
METEOROLOGICAL  
INSTRUMENTS  
ETC.

BRITISH MADE

THE SCIENTIFIC  
VALVE

**HIVAC LIMITED** Greenhill Crescent, Phone HARROW  
Harrow on the Hill, Middx. O895

*Pedigree*

The Goodmans Loudspeaker of to-day is the latest of a long line of instruments, each the product of the same policy of forward-looking research and development adopted by the company at its inception nearly a quarter of a century ago. The 18-inch model illustrated is a thoroughbred that carries on the established Goodmans "tradition of excellence."

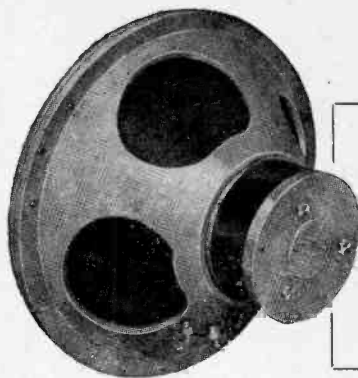

Overall Diameter . . 18"  
 Power Handling  
 Capacity . . 50 watts.  
 Flux Density  
 14,000 gauss.  
 Total Flux  
 270,000 maxwells.  
 Weight . . . . 35 lbs.

**GOODMANS**  
*Loudspeakers*



GOODMANS INDUSTRIES LTD • LANCELOT ROAD • WEMBLEY • MIDDX.

## Study television at its source! ★



★ read about  
 this new  
 opportunity

Special three-week practical Laboratory/Workshop Courses in Radio and Television Servicing are commencing in April. Send for details.

**E.M.I. Research and Development** Laboratories were largely responsible for the Marconi-E.M.I. system of television transmission used by the B.B.C. Service—the first in the world.

**E.M.I. Factories** produce the finest television receivers in the world.

**E.M.I. Service** department is the largest and most expertly equipped in the country.

**NOW—E.M.I.** have set up a TRAINING ORGANISATION to provide immediate courses on practical TELEVISION (Postal and College Courses.)

**SOON** this new Training College will extend its syllabus to cover all branches of Electronic Science.

**This is your** opportunity to secure a thorough training in Television from the very pioneers of the Science.

Ask your local H.M.V. dealer for further details or send for our free pamphlet which gives full details of this and other courses.

## E.M.I. INSTITUTES, LTD.

Dept. 16 • 43 GROVE PARK ROAD • CHISWICK • LONDON • W.4

Associated Company of:

THE GRAMOPHONE CO. LTD.  
 ("HIS MASTER'S VOICE")  
 THE MARCONIPHONE CO. LTD.  
 MARCONI-E.M.I. TELEVISION CO. LTD.  
 RADIOMOBILE LTD., ETC. ETC.

# U.I.C.

## METALLISED CERAMICS

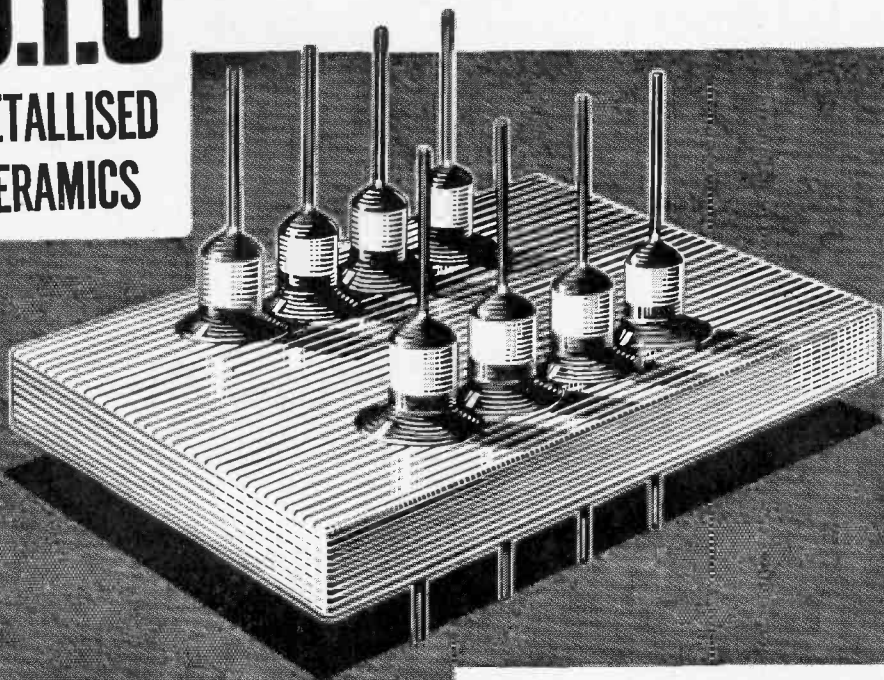

**W**e specialise in the production of all types of Metallised Ceramic components—Hermetic Seals, Sealed Lids, Tag Boards, Bushes, Formers, etc. These are available in soldered, coppered or silvered finish, according to requirements. The suitability of any finish is a matter which we shall be pleased to discuss.

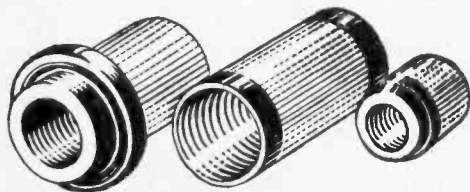

### HERMETIC SEAL TYPE HS 421

Flashover Voltage  
over outside path  
4.5 KVDC at 20° C.  
Flashover Voltage  
over inside path  
3.5 KVDC at 20° C.  
Small size. Close  
assembly. Physi-  
cally robust.

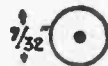
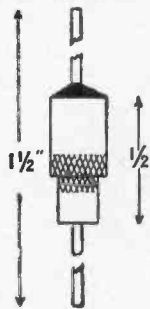

Components made to standard design  
or to customers' specific requirements.  
Write for details.

**UNITED INSULATOR CO. LTD., OAKCROFT RD., TOLWORTH, SURBITON, SURREY**

Telephone : Elmbridge 5241 (6 lines)

Telegrams : Calanel, Surbiton

*Unsurpassed In Ceramics*

# Wireless World

Radio and Electronics

Proprietors:  
ILIFFE & SONS LTD.

37th YEAR OF PUBLICATION

Branch Offices:  
COVENTRY :  
8-10, Corporation Street.  
Telephone: Coventry 5210.  
Telegrams :  
" Autocar, Coventry."

Managing Editor:  
HUGH S. POCOCK,  
M.I.E.E.

MAY 1947

Editor:  
H. F. SMITH

MONTHLY COMMENTARY .. .. .	157
RADIO COMMUNICATION DEVELOPMENTS ..	158
DESIGN FOR A HIGH-QUALITY AMPLIFIER—2 By D. T. N. Williamson .. .. .	161
TELEVISION RECEIVER CONSTRUCTION—4 ..	164
DESIGN DATA (13) Corrected R. C. Coupling ..	170
NOISE FACTOR—3 By L. A. Moxon .. .. .	171
SHORT-WAVE CONDITIONS By T. W. Bennington	176
COMPONENT DESIGN TRENDS .. .. .	177
RANDOM RADIATIONS By "Diallist" .. .. .	182
PRE-EMPHASIS AND DE-EMPHASIS By " Cathode Ray " .. .. .	183
SIX-METRE TRANSATLANTIC SIGNALS By R. Naismith .. .. .	186
WORLD OF WIRELESS .. .. .	187
LETTERS TO THE EDITOR .. .. .	191
RECENT INVENTIONS .. .. .	194

BIRMINGHAM :  
King Edward House,  
New Street, 2.  
Telephone :  
Midland 7191 (7 lines).  
Telegrams :  
" Autopress, Birmingham."

Editorial, Advertising  
and Publishing Offices:  
DORSET HOUSE,  
STAMFORD STREET,  
LONDON, S.E.1.

MANCHESTER :  
260, Deansgate, 3.  
Telephone :  
Blackfriars 4412 (4 lines).  
Telegrams :  
" Iliffe, Manchester."

Telephone :  
Waterloo 3333 (50 lines).  
Telegrams :  
" Ethaworld, Sedist, London."

GLASGOW :  
26B, Renfield Street, C.2.  
Telephone : Central 4857.  
Telegrams : "Iliffe, Glasgow."

△  
PUBLISHED  
MONTHLY

Price: 1/6

(Publication date 26th  
of preceding month)

Subscription Rate :  
Home and Abroad  
20/- per annum.

△  
*As many of the circuits and  
apparatus described in these  
pages are covered by patents,  
readers are advised, before  
making use of them, to satisfy  
themselves that they would  
not be infringing patents.*

**WEARITE**

**"P" COILS  
AVAILABLE NOW...**

... In all ranges from 12-2000 metres, including Aerial, H.F. Transformers and Oscillators.

Don't be put off with excuses if your dealer cannot supply the famous "Wearite" series of "P" Coils and I.F. Transformers from stock. There's no reason why you can't have them on demand—they're available NOW! If any difficulty, write to us giving your dealer's name and address.

Wright & Weaire Ltd., 2 Lord North Street, London, S.W.1.  
Telephone: ABBey 2126.      Factory: South Shields, Co. Durham.



# VALVES AND THEIR APPLICATIONS

By M. G. SCROGGIE, B.Sc., M.I.E.E.

## No. 5: Mullard LOW MICROPHONY PENTODE EF37

**T**HE main difficulties with high-gain audio amplifiers are fluctuation noise, hum, and microphony. Noise has been much discussed during the last few years, and precautions against hum have recently been explained in detail.\* Less has been said about microphony, but it can be very annoying. To minimize noise and hum it is generally necessary to place the first stage of amplification as close as practicable to the microphone or other sound pick-up. The first valve may thus be more or less exposed to the sound and will make an unauthorized contribution as a microphone — but not a high-fidelity one! In addition, wherever it is installed it may pick up vibrations and inject them into the programme. And if it is within sound of the loudspeaker there is the further risk of acoustic feedback, causing peaks in the response, or even sustained howls.

The obvious solution is to protect the valve from any sound or vibration, by mounting it on rubber and wrapping it around with perhaps several lots of sound-absorbing material. If the valve is badly microphonic, it is surprising how much of this sort of thing may be needed. Such trouble can be avoided by using an anti-microphonic type of valve.

The EF37 has been designed with this particularly in view. The X-ray photograph shows the double mica supports at top and bottom of the electrode assembly, which make the structure much more rigid.

In other respects, also, it is suitable in the first stage of a high-gain amplifier. Being a pentode, it can yield a gain over the a.f. band of 150-200 times, which is sufficient for the noise and hum contributions of reasonably-designed subsequent stages (and its own anode resistor) to be neglected. And difficulties due to Miller effect are avoided. However, the valve can be used as a triode if preferred.

\* P. J. Baxandall, "Wireless World", Feb. 1947, pp. 57-61.

The top-cap control-grid connection helps to make a low hum level possible. Another help is to connect the usual "hum-dinger" heater tapping to a point 5 or 6 volts more positive than the cathode.

To test microphony I made up a special high-gain amplifier. With the first valve on a rigid holder and completely unshielded from the loudspeaker, it was possible to provoke a howl with an EF37 first stage, but only when the gain was turned up to a point at which thermal-agitation noise was excessive. Under practical conditions with a modicum of acoustic protection, and usable gain not greatly exceeded, the likelihood of microphonic trouble would be remote.

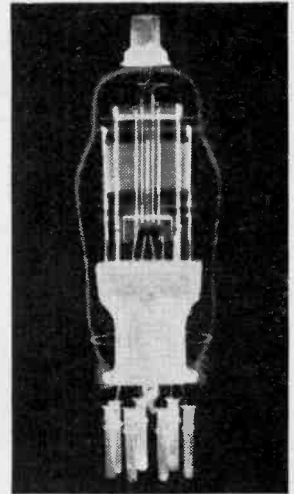

*This is the fifth of a series written by M. G. Scroggie, B.Sc., M.I.E.E., the well-known Consulting Radio Engineer. Reprints for schools and technical colleges may be obtained free of charge from:*

**THE MULLARD WIRELESS SERVICE CO. LTD.,  
TECHNICAL PUBLICATIONS DEPARTMENT,  
CENTURY HOUSE, SHAFTESBURY AVE., W.C.2**

# Wireless World

Radio and Electronics

Vol. LIII. No. 5

MAY, 1947

Price 1s. 6d.

## Monthly Commentary

### Live or . . . . Recorded ?

IN our last issue a correspondent, referring to the discussion in our pages on the quality of B.B.C. transmissions, expressed himself as strongly in favour of recordings as opposed to "live" broadcasts. The argument in support was mainly that recordings can be made at leisure and so the programme can be polished to a high state of artistic perfection before transmission. Another strong argument is that recordings of the best programmes can be transmitted at peak listening hours, without regard to the availability of performers or to the timing of events forming the subject of the broadcasts.

Considered in the light of pure reason, it is indeed difficult to controvert these arguments, always assuming that the quality of recordings can be made good enough to do justice to the great majority of the receivers in use or to the natural limitations at present imposed on transmission quality. But this is a matter that cannot be considered on a severely technical and reasonable basis; many other factors—psychological, artistic and of expediency—must be taken into account. The whole question is thus rather beyond the scope of a journal like *Wireless World*, but the correct use of the medium of broadcasting is of such high importance to all of us that the issue cannot be shirked.

A surprisingly large number of readers has written to express strong disagreement with our original correspondent's support of recordings. Although we cannot agree with the reasons put forward by the majority of the writers of these letters, we do agree most heartily with them that recording used unnecessarily is a bad thing. Its extensive use is certain to cause a decline in the appeal of broadcasting, of which the outstanding advantage over other media is its power of presenting living actualities, and to some extent at least to

convey to the listener the illusion that he is actually participating in the event. American broadcasters exploit the advantages of the "live" programme to the full, but the B.B.C. makes no secret of its liking for recordings. There is also the question of incentive or stimulus to the broadcasters, which seems to be so sadly lacking when they are constantly working on recordings. One is forced to the natural but rather trite conclusion that unless programmes are "live" they run a grave risk of becoming "dead."

### Meaningless Superlatives

IN last month's issue we expressed our growing dissatisfaction with existing methods of classifying the frequency and wavelength bands used in radio communication. In particular, we protested against the arbitrary assignment of precise significance to such vague comparatives and superlatives as "very," "ultra" and "super." One never knows when a writer or speaker is using these terms in the officially accepted sense, as his fancy dictates, or is being deliberately vague.

Since expressing these views, we are confirmed in our opinion that such terms are quite intolerable: nothing like them is to be found in any other branch of science or technology. But it has been pointed out that our suggestion for using the term "very high" to describe all frequencies above 30 Mc/s is open to the objection that "very" has already been given a precise meaning in the British Standards Glossary. We agree, and substitute the word "extra" in the amended table of proposed classifications printed below.

Bands		Wavelength designation	Frequency designation
Frequency	Wavelength		
1. Below 300 kc/s ...	Above 1,000 m	Long	Low
2. 300—3,000 kc/s ...	1,000—100 m	Medium	Medium
3. 3—30 Mc/s ...	100—10 m	Short	High
4. 30—300 Mc/s ...	10—1 m	Metre	Extra High
5. 300—3,000 Mc/s ...	1—0.1 m	Decimetre	
6. 3,000—30,000 Mc/s ...	0.1—0.01 m	Centimetre	



Post Office S-W transmitter station building at Criggion near Shrewsbury.

# RADIO - COMMUNICATION DEVELOPMENTS

## Survey of Advances Since 1939

FROM the 25th to the 28th March and on the 2nd April the Institution of Electrical Engineers held a Convention at which papers were read to describe the wartime uses of radio in communications. Although similar in its plan to the Radiolocation Convention of a year earlier, the papers were in most cases of a very different nature for there was a distinct tendency to stress operational aspects rather than technical.

This is very largely due to the very different character of communications development. Prior to the war, it was on a well-established basis and wartime development has been chiefly to meet specific war requirements, among which reliability, light weight, robustness and the ability to withstand extremes of temperature and humidity were of the greatest importance. While these were also requisites of radar equipment, the purely technical problems of circuit technique — problems often of an entirely new kind — formed the major interest.

Nothing analogous to this occurred in the field of communications for although the pulse communication systems certainly opened a new branch with a new circuit technique they owe much to radar practice.

New and unfamiliar circuit practices in communication sets are dictated largely by military needs and are, therefore, often ones which have little or no civil application. For the infantry patrol set, for instance, a number of ingenious "netting" devices were developed. At a time when

the supply position made the use of quartz crystals impracticable, it was required that any one of a group of man-pack sets should be able to transmit and be received at once by all others in the group.

Various methods were developed to enable the operator not only to keep his transmitter and receiver tuned to the same frequency but to the scheduled net frequency for the operation in hand. The methods evolved gradually transferred the difficulties from the operator to the factory.

This is but one example of a general tendency, and one which will unquestionably persist in peacetime, to simplify the operation of equipment even if it involves complication in design and maintenance, to say nothing of manufacture.

Apart from this the new things in communications were often the development of existing methods for some new purpose. A case in point is the use of really high frequencies for communication purposes. Frequencies of 30-150 Mc/s were well known before the war and had been used for experimental communication links as well as for television. There was, however, no deep knowledge about their propagation characteristics particularly in heavily wooded country and the jungle.

It was realized that under such conditions the attenuation would be severe and this unquestionably retarded their adoption for infantry patrol and tank sets, most of which continued to operate

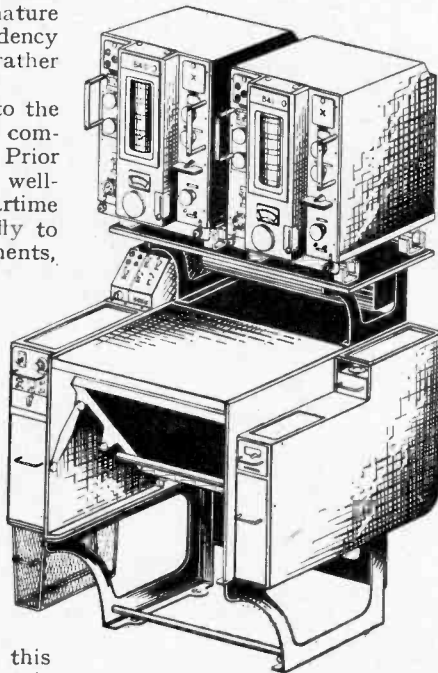

A modern "pre-fabricated" naval receiving bay, with typewriter cabinet (typewriter housed under desk). The two Murphy receivers shown were described in *Wireless World* for December, 1946.



## Radio-Communication

## Developments—

in the H.F. band below 9 Mc/s throughout the war, in spite of its congestion. However, extensive trials proved that the heavy attenuation of metre waves in the jungle was more than offset by the lower noise level, particularly at night, and the greater efficiency of the aerial. Towards the end of the war, therefore, such sets were looked upon with marked favour.

At such short wavelengths the use of frequency modulation has special advantages for military purposes, largely because of the increased efficiency of the transmitter. Although large deviations are needed for the highest signal-noise ratio, it has been found that with deviations above 1.5:1, over 80 per cent of the power is in the sidebands and for the particular requirements of the Services a ratio of around 2:1 appears adequate. This leads to quite narrow-band frequency-modulation systems.

For aircraft purposes, of course, these wavelengths were widely used, for the same attenuation problems did not arise and there was considerable ingenuity in the development of stable systems giving easy channel selection.

A tremendous amount of work was done on pulse modulation in order to obtain a multi-channel equipment radiating only a very narrow beam in the interests of secrecy. Such a beam could only be obtained with an aerial system of reasonable dimensions by adopting centimetre waves, and at the time when the scheme was first mooted this in turn virtually involved the use of the magnetron. This is a valve which is quite difficult to modulate by ordinary methods, but which lends itself well to pulse modulation.

Thus the desire for a narrow beam of radiation ended by requiring the use of pulse modulation, and the simplest way of obtaining multi-channel operation proved to lie in the use of interlaced pulses on a so-called time-division basis, as distinct from the usual frequency-division adopted in ordinary carrier equipment. It is not necessary to go into this in detail for it resulted in the No.

10 set, which has been previously dealt with<sup>1</sup>.

In spite of its success the equipment had one drawback. It required inputs at audio-frequency for each of its eight channels and so when inserted in a cable route, for which a carrier system on a frequency-division basis is used, carrier-terminating equipment was needed to interconnect the cable and the No. 10-set radio links. With a conventional radio link capable of handling channels on the frequency-division system this is not necessary. Future development of the pulse modulation system would seem to lie in methods which enable it to be

Frequency-division multi-channel equipment was adopted in the No. 26 set on frequencies around 100 Mc/s. Although of higher power, the lower aerial gain and the semi-optical properties of even 100 Mc/s result in little more range than with the 6-cm No. 10 set.

On long-distance circuits, such as those used for transatlantic telephony by the G.P.O., single-sideband operation with reduced carrier has marked advantages over double-sideband. There is but little power radiated in the absence of modulation, which is economical, and the power-handling capacity of the final R.F.

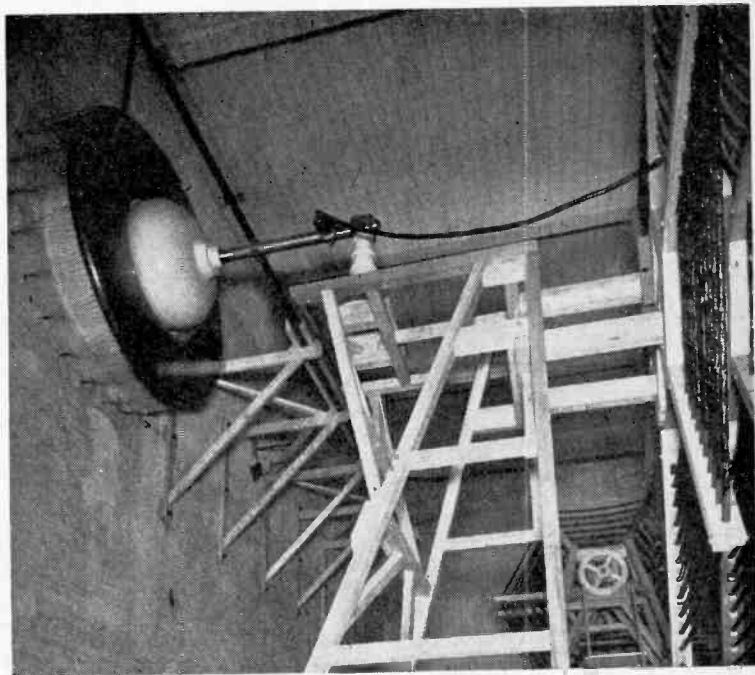

Inductance room for the long-wave transmitter at the Post Office Criggion station, showing the aerial lead-in.

used on a frequency-division system and the time-division system would seem more suited to circuits in which cables are not involved.

<sup>1</sup> Pulse Width Modulation, *Wireless World*, December, 1945.

Army Set No. 10, *Wireless World*, December, 1945.

Pulse Time Modulation, *Wireless World*, February, 1946.

Multi-Channel Pulse Modulation, *Wireless World*, June, 1946.

Army No. 10 Set, *Wireless World*, September, 1946.

amplifier is available for dealing only with the one sideband instead of the two sidebands and carrier of a double-sideband system. Substantially more power can thus be radiated and a narrower-band receiver can be used, resulting in an improvement of some 9 db in the signal-noise ratio.

The carrier is not entirely suppressed but is transmitted at 26 db below the peak power of the transmitter so that it serves as a pilot to control the insertion of a local carrier at the receiver.

One of the greatest advantages of single-sideband operation lies in the reduced distortion under fading conditions, and this applies also to the single-sideband reception of a double-sideband transmission. Indeed, in this case one can go further and use two receivers to receive the two side-

bands in the power-handling capacity of the sender.

At the "Propagation" session of the Convention two very interesting papers were read—one by Sir Edward Appleton and another by K. W. Tremellen and J. W. Cox. These papers are of particular value because within them are

band of frequencies, varying constantly with distance, time of day, season, epoch of the sunspot cycle and with geographic and geomagnetic latitude and longitude, and the ultimate aim is to predict all the variables, and to chart the future ionosphere conditions on a world-wide basis, so that the usable frequency band will be clearly indicated at any time and place. This object is now achievable, and the Appleton Paper described in detail the nature of some of the difficulties encountered and the measures taken to bring the theoretical and scientific data into a form applicable to engineering needs.

The Tremellen and Cox paper concentrated rather more fully on the engineering problems. From a communication point of view, a transmission path via the ionosphere was considered as behaving like a band-pass filter, introducing noise and distortion as well as attenuation, and, since the characteristics of the filter are not under human control, the problem consists of being able to calculate or predict the properties in the pass-band for any time or place. A comprehensive survey of the principles behind the production of ionospheric contour charts was given, as well as details of the way in which they should be used. It was pointed out that perfection in these methods is still a long way ahead, particularly as regards the calculation of the low-frequency limit of the pass-band, which is a complex operation depending upon many factors, such as ionospheric absorption, atmospheric noise, power radiated, etc. Nevertheless, "at present we do the best we can," and continually improve the methods as more data is acquired. The prediction of ionospheric storms was another matter upon which more knowledge was required before anything like success could be expected.

(A list of papers read at the Convention appears on p. 181.)

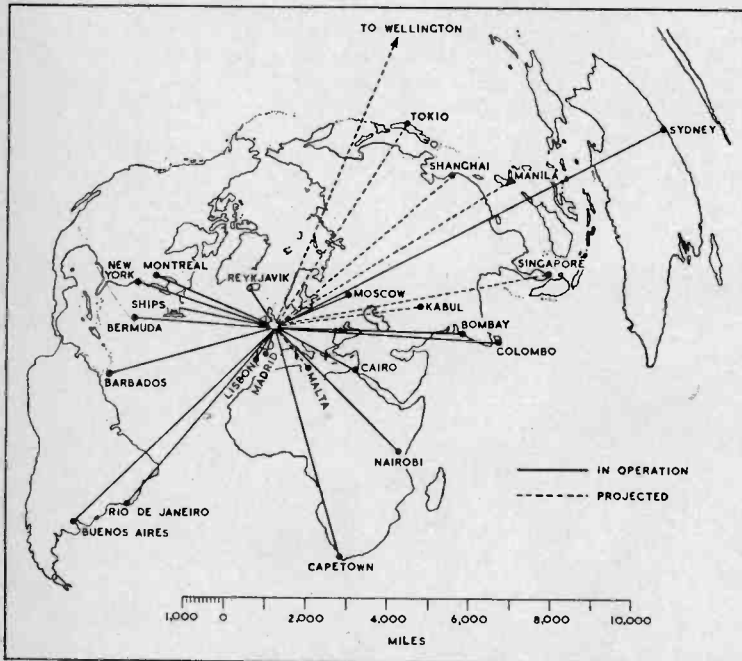

Zenithal azimuthal projection map showing Post Office radio-telephone circuits with their true bearing and distance from London.

bands independently and then combine the A.F. signals to give a form of diversity reception.

An ingenious M.C.W. multi-channel telegraph system was devised. It is of the sub-carrier type in which each sub-carrier is modulated by a keyed audio tone (900 c/s). The phases of the tones used for the channels are arranged to be displaced by  $360/n$  degrees where  $n$  is the number of channels.

For a two-channel system the audio tones are  $180^\circ$  out of phase, and because of this the peak voltage for equal modulation depths on both channels is no more than for single channel operation. With three channels at  $120^\circ$  phase angles the peak voltage is greater and the amplitude of each sub-carrier must be reduced to two-thirds of that with one or two channels. The system obviously results in a considerable increase

contained, in condensed and easily usable form, a comprehensive survey of ionospheric knowledge as it stands to-day, including historical data regarding the accumulation of the knowledge, scientific details of the world-wide ionospheric structure and of its continual variations, and explanations of the engineering techniques for the application of the ionospheric data to radio communication. The two papers cannot fail to become the main source of reference for those engaged in short-wave communication for some time to come.

In presenting his paper Sir Edward Appleton pointed out that the two basic relations in ionospheric work are the  $(h^1, f)$ , which determines the highest frequency on which it is possible to communicate, and the  $(- \log \rho, f)$ , which determines the lowest. Between these two is the usable

## OUR COVER

The Criggon long-wave station was built as a war-time stand-by for Rugby. Materials for masts were scarce and the illustration shows how the aerial system is partly supported by a high cliff or bluff rising above the banks of the River Severn. The transmitter operates on the Rugby frequency of 16 kc/s.



**Design for a High-Quality Amplifier**—to compensate for any inequality in gain.

**Output Stage.**—The balance of quiescent anode current in the output stage is a matter of some importance, as it affects the performance of the output transformer to a marked degree. In this amplifier, provision is made, by means of a network in the cathode circuits of the KT66 valves, for altering the grid bias of each valve, giving complete control of the static conditions of the stage. A feature of this arrangement is that the valves operate with a common unby-passed cathode bias resistor, which assists in preserving the balance of the stage under dynamic conditions.

**Output Transformer.**—The turns ratio of the output transformer will be determined by the impedance of the loudspeaker load. It is convenient to make each secondary section of such an impedance that by series-parallel arrangement a number of suitable load impedances may be provided utilizing all the sections of the transformer. A suitable value of impedance is 1.7 ohms per section, giving alternatives of 1.7, 6.8, 15.3, 27 ohms, etc.

Winding data for a suitable transformer are given in the appendix.

**Negative Feedback Network.**—The design of this amplifier is such that no difficulty should be experienced in the application of negative feedback up to a maximum of some 30db. Pro-

Oscillograms of input-output characteristic; left hand column, without feedback; right hand column, with feedback. (1) At 300 c/s with slight overload (2) At 300 c/s, output voltage 15% below maximum. (3) and (4) Conditions as in (1) and (2) respectively, but at 30 c/s.

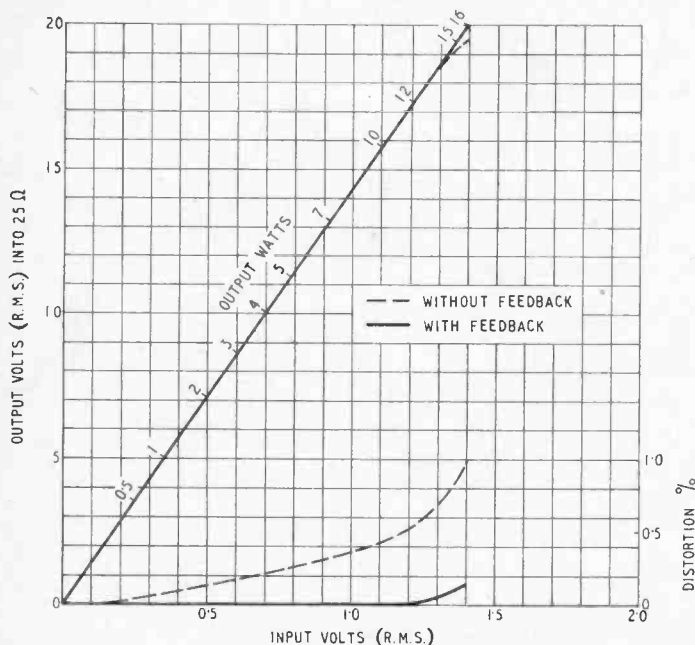
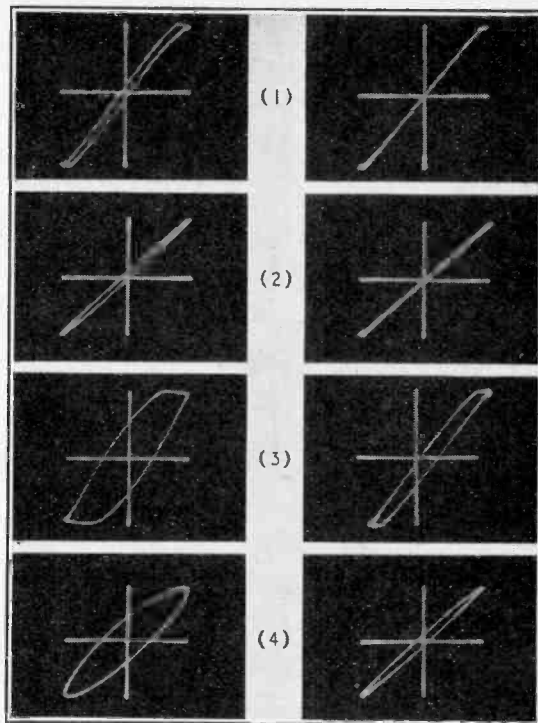

Fig. 6. Input-output characteristic and harmonic distortion curves, with and without feedback.

vided that the threshold of instability is not reached, the benefits of negative feedback increase as the amount of feedback

is increased, at the sole expense of loss of gain, but there will be little if any audible improvement to be gained with this amplifier by increasing the amount of feedback beyond 20db.

The feedback network is a purely resistive potential divider, the bottom limb of which is the cathode bias resistor of the first stage.

With component values as specified no trouble should be experienced from instability due to the effects of unintentional positive feedback. Should instability arise it will probably appear as oscillation at a supersonic frequency. This may be transient, occurring only at some part of the cycle when the amplifier is operated near maximum output. Its cause may be bad layout or an output transformer with a higher leakage reactance than specified, or it may be due to resonance in the output transformer.

A remedy, which should only be used as a temporary measure, is to reduce the high-frequency response of one of the amplifier stages, so reducing the loop gain at the frequency of oscillation to a value below unity. This may

conveniently be done by connecting a small capacitor (say 200 pF) in series with a 5,000Ω resistor from the anode of V<sub>1</sub> to chassis.

**Performance**

**Linearity.**—The linearity of the amplifier is well illustrated by the series of oscillograms. These show that, up to maximum output, the linearity is of a high order, and that the overload characteristic is of the desirable type shown in Fig. 1(b) in the previous issue. The improvement due to the application of negative feedback, especially at low frequencies, is clearly demonstrated by the oscillograms.

Equipment for measuring inter-modulation products was not available, but measurement of the total harmonic distortion was made with an input frequency of 400 c/s. The result is shown in Fig. 6, from which it will be seen that the harmonic distortion at maximum rated output (15 watts) is less than 0.1 per cent. Inter-modulation, with this degree of linearity, is not present to an audible degree.

**Frequency Response.**—The frequency response of the amplifier is greatly dependent upon the characteristics of the output transformer. In the amplifier tested, the output transformer had a resonance at about 60 kc/s which

put resistance of the amplifier is 0.5 ohms measured at the 15-ohm output terminals.

**Noise Level.**—In the amplifier tested, the measured noise level was 85 db below maximum output. The noise in this amplifier was, however, almost entirely 50c/s

tests using a direct microphone circuit with noises such as jingling keys reveal extraordinary realism.

The amplifier can be described as virtually perfect for sound-reproducing channels of the highest fidelity. It provides an ideal amplifier for sound-recording pur-

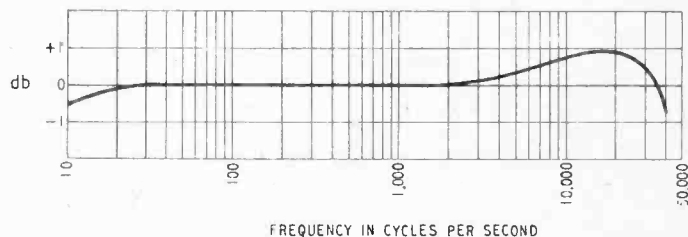

Fig. 7. Frequency response (without feedback) of 20 watt output transformer described in appendix. Generator resistance 2,500Ω load resistance 1.7Ω. Measured with 5V R.M.S. on primary. At higher excitations the bass response improves progressively up to saturation.

hum, caused by coupling between the mains and output transformers. By more careful arrangement of these components it appeared that the noise level could be reduced to better than 100 db below maximum output.

If desired, the power output of the amplifier may be increased beyond 15 watts by the use of several pairs of output valves in parallel push-pull. The output transformer, power supply and bias arrangements, and the feedback resistor R<sub>25</sub> will require to be modified. Amplifiers of this

poses, where "distortionless" amplification and low noise level are of prime importance.

**APPENDIX.  
Output Transformer.**

- Specification.**  
 Primary load impedance = 10,000 ohms C.T.  
 Secondary load impedance = 1.7 ohms per section.  
 Turns ratio = 76 : 1.  
 Primary inductance = 100 H (min.)  
 Leakage inductance = 30 mH (max.)

**Winding Data.**  
 Core: 1½ in stack of Pattern No. 28A "Super Silcor" laminations. (Magnetic and Electrical Alloys.)

The winding consists of two identical interleaved coils, each 1½ in wide, wound on 1½ in × 1½ in paxolin formers. On each former is wound: 5 primary sections each consisting of 5 layers (88 turns per layer) of 30 S.W.G. enam. copper wire interleaved with 2 mil. paper, alternating with 4 secondary sections, each consisting of 2 layers (29 turns per layer) of 19 S.W.G. enam. copper wire, interleaved with 2 mil. paper.

Each section is insulated from its neighbours by 3 layers of 5 mil. Empire tape. All connections are brought out on one side of the winding, but the primary sections may be connected in series when winding, only two primary connections per coil being brought out.

**Measured Performance.**  
 Primary inductance = 100 H.  
 (measured at 50 c/s with 5V R.M.S. on primary, equivalent to 2.5 mW)  
 Leakage inductance = 22 mH.  
 (measured at 1,000 c/s)  
 Primary resistance = 250 ohms.

The frequency response curve is given in Fig. 7.

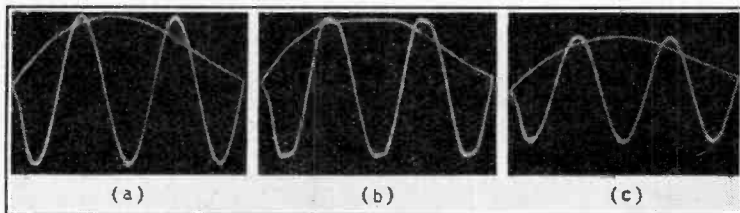

(a) Input waveform, 300 c/s. (b) Output waveform with feedback and slight overload. (c) Output waveform with feedback but output voltage 15% below maximum.

caused a sharp dip of 2.6 db around this frequency. The characteristic within the audible range from 10-20,000 c/s is linear within 0.2 db.

**Phase Shift.**—The excellence of the frequency response characteristic indicates that little phase shift is present. Phase shift is only apparent at the extremes of the AF spectrum and never exceeds a few degrees.

**Output Resistance.**—The out-

design with power outputs up to 70 watts have been produced.

Listening tests carried out in conjunction with a wide-range loudspeaker system have fully supported the measured performance. No distortion can be detected, even when the amplifier is reproducing organ music including pedal notes of the 20 c/s order, which reach the threshold of maximum output. Transients are reproduced with extreme fidelity;

# TELEVISION RECEIVER

## 4.—Frame Time Base and Sync Separator

# CONSTRUCTION

A SAW-TOOTH current wave with a repetition frequency of 50 c/s is needed for vertical deflection, and is generated by the frame time-base. Synchronism with the transmission is effected by locking it to the synchronizing pulses in the transmission. One limiter is employed to separate the sync pulses from the picture signal and its output is used to lock both the line and frame time-bases. A further limiter is needed in the frame circuit in order to remove the line pulses. It is purely a matter of mechanical convenience that both these limiters are included in the same unit as the frame time-base proper.

The circuit of this unit is shown in Fig. 1 and the saw-tooth generator is  $V_3$ . The valve is an

variations (6J7G, 6J7GT, etc.). The valve is chosen in preference to a triode simply in order to keep down the number of different types of valve used in the complete equipment.  $V_2$  is of the same kind and it is also used in other units.

For the moment ignore the connections to the anode of  $V_2$  and to  $R_{14}$ . The circuit of  $V_3$  is then merely that of a grid-leak oscillator in which the  $I-I$  ratio transformer  $T_1$  replaces the tuned circuit and in which the grid leak  $R_{12} + R_{13}$  is returned to positive H.T. instead of to cathode;  $C_6$  is the grid capacitor. The valve commences to oscillate at a frequency determined by the constants of  $T_1$  and the stray capacitance, but so much charge is accumulated on  $C_6$  by the grid

across  $L_1$  acts against the H.T. to drop the anode voltage, but the induced voltage in  $L_2$  drives the grid potential in a positive direction. This further increases the anode current and results in the grid being still further driven positive. The induced voltage in  $L_2$  can be quite large—say, 100 volts—but the grid is not positive with respect to its cathode by this amount. Grid current flows into  $C_6$  and charges it so that its upper terminal becomes negative with respect to earth and cathode, and the grid-cathode voltage is the sum of the induced voltage in  $L_2$  and the voltage on  $C_6$ . The latter is nearly equal to the former, and the grid is never more than a few volts positive with respect to cathode.

The anode current does not

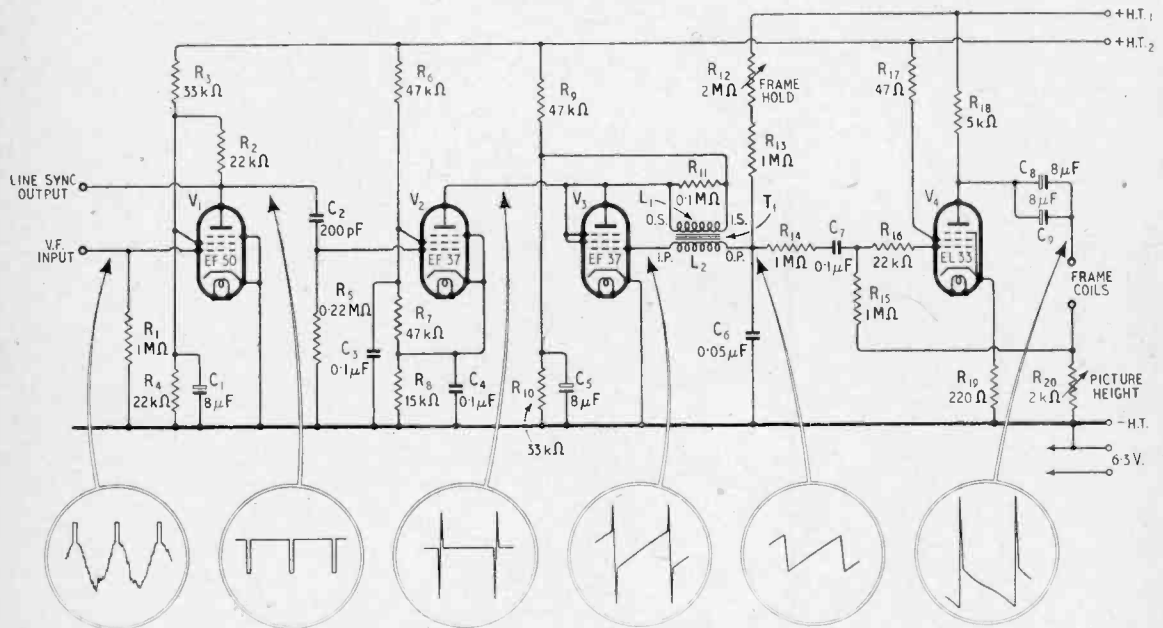

Fig. 1. The circuit diagram of the sync separator and frame time-base is shown here.  $V_1$  is the main sync separator and  $V_2$  the frame pulse separator;  $V_3$  is the frame blocking-oscillator saw-tooth generator and  $V_4$  the output valve feeding the deflector coils.

EF37 connected as a triode; the characteristics needed are in no way critical and the EF36 can be used instead. As another alternative, there is the 6J7 and its

current that after one-half cycle of oscillation the valve is cut off.

More precisely, and starting at a time when the anode current is rising, the back E.M.F. developed

continue to rise indefinitely. The anode potential becomes very low because of the back E.M.F. across  $L_1$  and the rate of rise of current falls off. Because of this

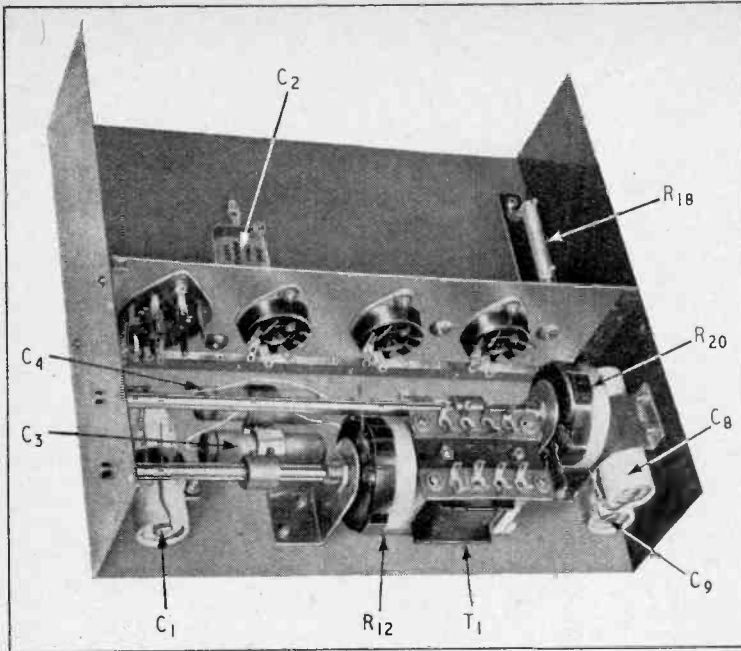

View of the chassis with the components in place before wiring.

the induced E.M.F. in  $L_2$  starts to drop, which further reduces the rate of rise of current. The current very soon starts to fall and then the induced E.M.F. reverses its sign and becomes negative, and the valve is very rapidly cut off.

The terminal OP on the transformer, which is joined to  $C_8$ , is negative to earth by the voltage on  $C_8$ ; it is at, perhaps,  $-90$  V. Because  $L_2$  is a part of a resonant circuit, however, IP is not at the same potential and through the fly-wheel effect it swings still more negative. IP cannot swing more negative than OP by more than it was positive to OP when the valve was conductive—perhaps 100 V. Losses in the circuit make the swing less than this and in fact it is imperative to have high losses if the valve is to function properly as a blocking oscillator.

If the losses are such that the overswing is 50 per cent, then for 100 volts initially the overswing is to  $-50$  volts, and with  $-90$  V on  $C_8$ , the grid swings negative to  $-140$  V. This is followed by a positive swing and again with 50 per cent overswing, IP becomes 25 V positive to OP and the grid

is  $-90 + 25 = -65$  V to cathode.

This is well beyond cut-off so that the valve is kept cut off by the charge on  $C_8$  and cannot oscillate again until either this has

disappeared or the grid is driven sufficiently positive by some external agency.

It is particularly to be noted that this action would not occur if the overswing were too great. Thus, if there were 90 per cent overswing, the first swing across  $L_2$  would be from  $+100$  V to  $-90$  V and the second to  $+81$  V. With  $-90$  V on  $C_8$ , the grid would then be  $-9$  V only with respect to cathode. The valve might well conduct and regeneration would start. The stage would, in fact, act as a class C "sine-wave" oscillator.

For the proper blocking action it is necessary to have a heavily damped resonant circuit and this is conveniently obtained from the core losses of the transformer. The heavy damping necessitates a high L/C ratio and tight coupling between the windings, both of which demand an iron-core. In this case, the core losses are not quite sufficient and an extra damping resistance  $R_{11}$  of 100 kΩ is added.

An exact analysis of the circuit is quite a complicated matter and is, fortunately, unnecessary, because the transformer constants are in no way critical. Almost any 1-1 ratio transformer of some 5-30 H inductance functions well;

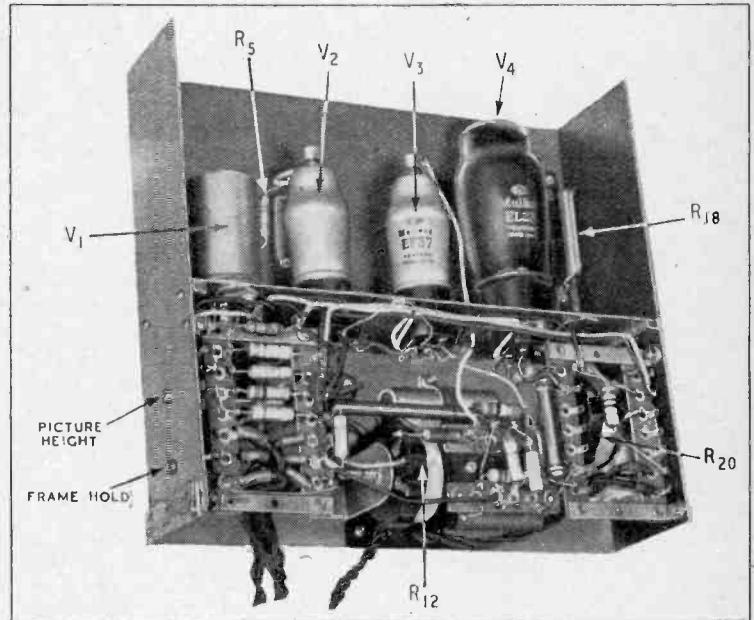

The finished unit. - The mounting bracket for  $R_{12}$  is clearly visible.

**Television Receiver Construction—** with some components a damping resistor across one of the windings

this. This is more of a safety measure than anything, for the lock is actually so hard that  $R_{12}$

to drive the grid above cut-off and start the trigger action in  $V_3$ . The pulse is obtained from  $V_7$ , which is normally cut off. It draws current on a sync pulse and this current flowing through  $L_1$  induces a positive-going pulse on the grid of  $V_3$ . In effect, therefore  $T_1$  is also used as a phase-reversing pulse transformer. In this way a saw-tooth wave of moderately good linearity and with an amplitude of about 65 V is produced across  $C_6$ . A portion of this is applied to the output valve  $V_4$ . If  $R_{20}$  is zero, one-half of the saw-tooth voltage is applied between the grid of  $V_4$  and earth since  $R_{14}$  and  $R_{15}$  are

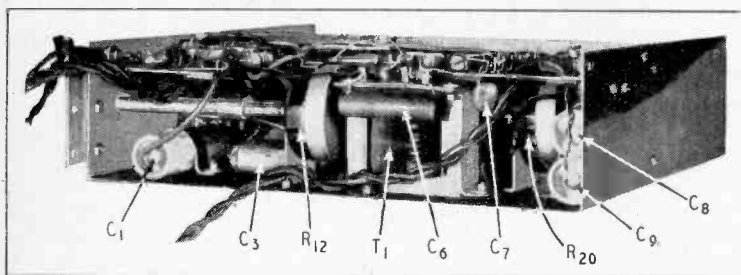

This view shows the blocking-oscillator transformer  $T_1$ ; the coupler for the extension shaft of  $R_{12}$  is visible. A similar coupler is used on  $R_{20}$ .

is needed, but not with others. Constructional details of a suitable component are given in Fig. 2. It consists simply of an iron-stack of the kind commonly used for small speaker transformers and two windings each of 3,000 turns of No. 41 or 42 enamelled wire. Several layers of insulating tape should be placed between the windings.

When  $V_2$  is cut off the upper terminal of  $C_6$  is at about  $-90$  V. If the grid leak were in shunt with it, it would discharge exponentially at a rate depending only on the CR product. The resulting saw-tooth would be positive-going but very far from linear, for the output needed would be a large fraction of the total voltage acting in circuit.

To linearize the discharge the grid leak  $R_{12} + R_{13}$  is returned to + H.T. I and the total voltage acting for the discharge of  $C_6$  is of the order of 500 V. The rate of discharge is governed by  $C_8$  ( $R_{12} + R_{13}$ ) and  $R_{12}$  is made variable to give some control over

can be varied over wide limits without affecting anything but picture height.

If no synchronizing signal is applied  $C_6$  discharges until the

A general view of the chassis with the valves removed, showing  $C_2$  and  $R_6$ .

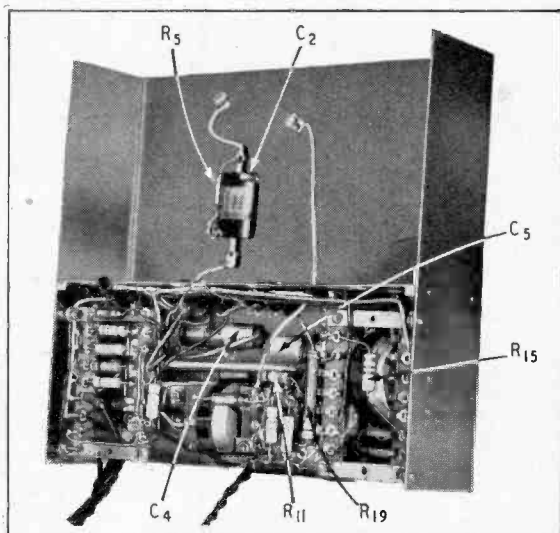

grid potential becomes below the cut-off value. Anode current then flows in  $V_3$  and the whole cycle recommences. In the synchronized condition, a positive-going sync pulse is applied to the grid before  $C_6$  has discharged so far and this is of sufficient amplitude

each of  $1$  M $\Omega$ . Because of negative feedback from  $R_{19}$  the grid-cathode voltage of  $V_4$  is less than this.  $V_4$  has  $g_m = 10$  mA/V and  $R_{19}$  is  $220 \Omega$ , so that feedback reduces the gain by 3.2 times and the actual input to  $V_4$  is only  $1/6.4$  of that across  $C_6$ . When  $R_{20}$  is not zero, further feedback occurs.

The resistors  $R_{16}$ ,  $R_{17}$  are merely stoppers to inhibit parasitic oscillation. The output valve itself is resistance-capacitance-coupled to the deflector coils (see Part 3), two capacitors  $C_8$  and  $C_9$  in parallel and of  $8 \mu F$  each being used because it is convenient to use small insulated types and such types are limited in their current rating. Both terminals must be insulated from earth.

The capacitance used is far from sufficient to give a linear

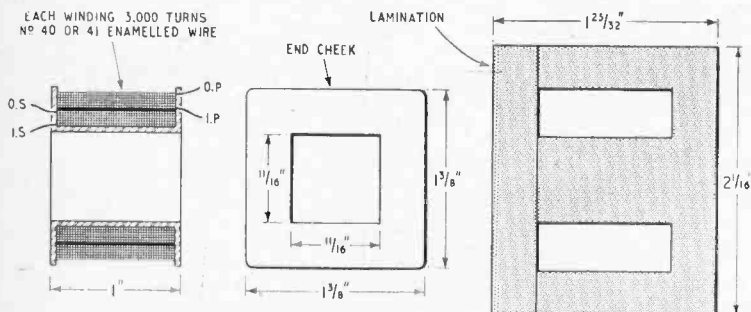

Fig. 2. Constructional details of the blocking-oscillator transformer. The laminations are Magnetic and Electrical Alloys Silcor I Pattern No. 74 or Richard Thomas & Baldwin's Quality No. 3B, Type E & I 86. The core is in no way critical and any lamination approximating to this size is satisfactory.



coil current and correction is obtained for this and for the non-linearity of the scan voltage on  $C_6$  by the inverse curvature of the valve characteristic. To help in this the bias resistor  $R_{19}$  is rather higher than usual.

Negative feedback from  $R_{20}$  reduces the remaining non-linearity to negligible proportions and the variable resistor  $R_{20}$  acts as a "Picture Height" control.

Turning now to sync separation,  $V_1$  is the main sync separator and it is fed with the V.F. signal—the grid being connected to the cathode of the C.R. tube through a  $0.1\text{-}\mu\text{F}$  capacitor. This component is not shown in Fig. 1 for it is most conveniently mounted outside this unit.

The sync pulses are positive-going at this point and D.C. restoration is effected with  $R_1$  of  $1\text{M}\Omega$  and the grid-cathode path of  $V_1$ . This valve is operated as a straightforward limiter with a fairly low screen voltage and the separated negative-going pulses in the anode circuit are fed to the line time-base and also through  $C_2R_5$ —a critical time constant differentiating circuit—to the frame limiter  $V_2$ .

The back edge of the first frame

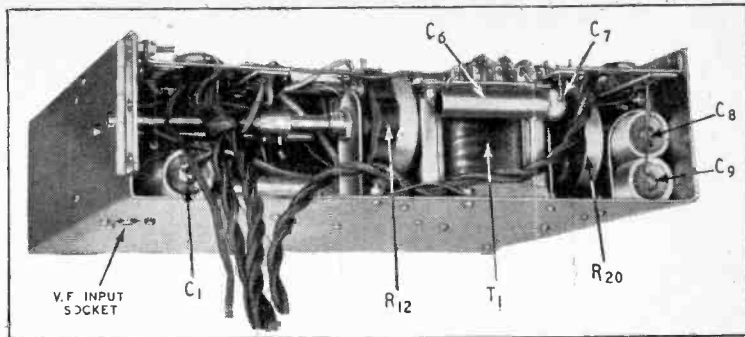

The V.F. input socket can be seen in this photograph. When the unit is mounted it comes close to the base of the C.R. tube.

pulse, is used for synchronizing, the line pulses being eliminated by  $V_2$ . The mode of operation was explained in the April issue, and it is to be noted that although the sync pulse output of  $V_1$  is negative-going the back edges of the frame pulses on the grid of  $V_2$  are positive-going. Consequently the pulses in the output of  $V_2$  are negative-going.

The waveforms to be expected at various points in the circuit are sketched in Fig. 1. It should be noted that those shown for the input and output of  $V_1$  are for the line pulses, whereas the rest are all frame-scanning signals.

The reason for this is that the detail of the frame synchronizing pulses cannot readily be observed on an ordinary oscilloscope and sync-separator checking is thus more readily done by observing the line pulses.

The photographs illustrating this article show the form of construction adopted. Later articles will make clear its inter-connection with other units and it is sufficient to say now that all connections save the V.F. input are taken to the tagboards by flexible leads. The chassis is mounted alongside the C.R. tube and hinged at the back so that

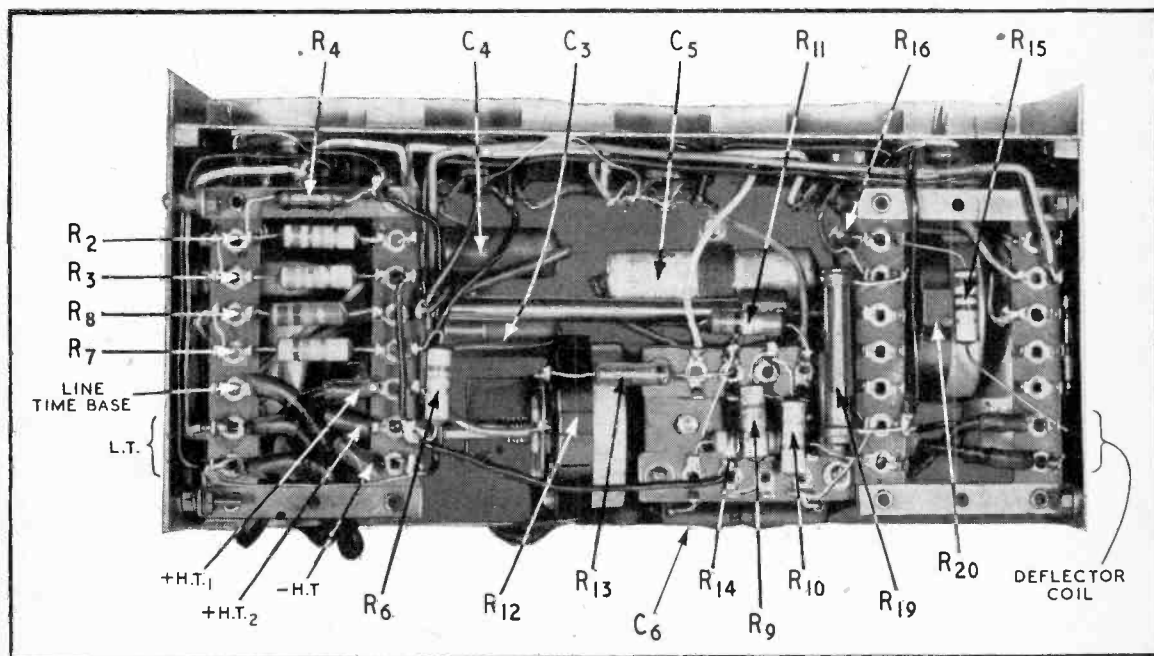

In this close-up of the unit most of the smaller parts are easily seen. The left-hand tagboard has six tags serving as junction points for the inter-unit connections.

### Television Receiver Construction—

for maintenance and experiment it can be swung clear of everything else and easy access to any part of it can be obtained.

The chassis has a height of 9in, a length of 9½in and a depth of 2½in and is bent from one piece of brass sheet. The valve shelf is supported by strips of ¼in × 3/16in brass rod screwed to chassis and shelf and is 5in below the top of the chassis. The V.F. input connector is an ordinary wander-plug socket mounted on a small strip of Paxolin and screwed to the chassis, with a large clearance hole to reduce capacitance.  $C_2$  is mounted close to the top of  $V_2$ , but spaced from the chassis, again to reduce the capacitance to it. It serves as a useful anchorage point for the grid lead.

No detailed drawings of the chassis are given since it is expected that minor variations in layout will have to be made to suit the particular components used. It should not be necessary to increase the chassis size however, and no major changes of layout are likely to be needed to accommodate any normal components.

The two variable resistors are mounted on brackets with extension rods for their operation, these extension rods having saw-cuts on the ends for screwdriver control. As they are set back by differing amounts the shaft centres can be only 1½in apart.

Fig. 3 shows the waveforms and their amplitudes at various points in the circuit. If the initial testing is done on the bench, and it is always a good plan to do this, a 1.7-k $\Omega$  resistor can be connected to the "Frame Coil" terminals in place of the coils themselves if this is more convenient. With such a resistor the high-voltage spikes on the wave on the anode of  $V_4$  will not be obtained since these are generated by the inductive back E.M.F. in the coils.  $V_1$  and  $V_2$  can, of course, only be

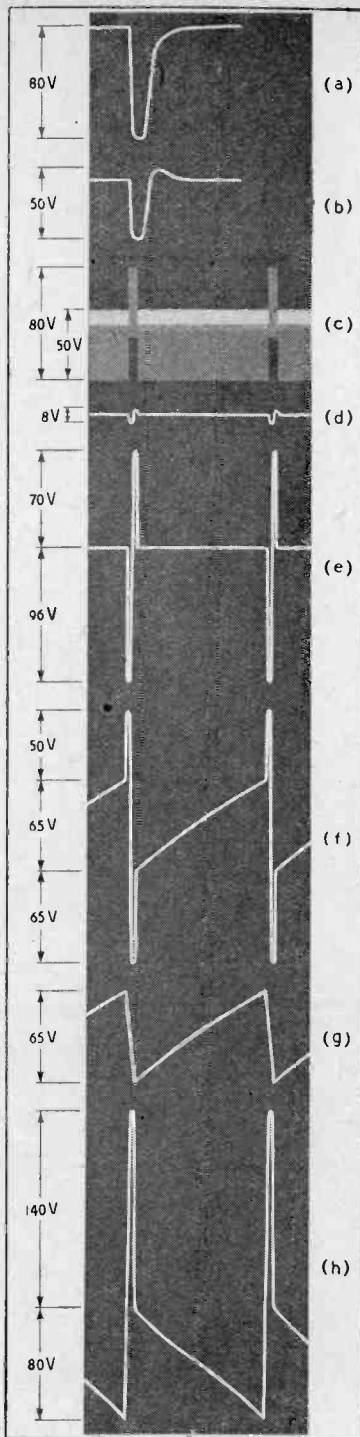

Fig. 3. Waveforms in the circuit. (a) and (b) are respectively the waveforms between the anode of  $V_1$  and earth and the grid of  $V_2$  and earth with  $V_3$  removed, a normal signal input and the oscilloscope adjusted to show components of line frequency; (c) is the grid voltage of  $V_2$  with the oscilloscope adjusted to show frame frequency as in all the remaining waveforms. (d) shows the anode waveform of  $V_2$  with  $V_3$  removed and (e) with  $V_3$  in place. (f) is the grid voltage of  $V_3$  and (g) the voltage across  $C_6$ , while (h) is the anode voltage of  $V_4$ .

checked with a V.F. input.

When checking on signals it is well to check the output of  $V_1$  closely, and it is instructive to replace  $R_4$  by a variable resistor while so doing. With an oscilloscope set to show the line pulses and with a high value for  $R_4$ , a large output is obtained from  $V_1$  and the V.F. signal will be visible between the pulses as a feathery band of light. As  $R_4$  is reduced the pulse output will fall slightly, and the picture signal rapidly, until a critical value is reached at which the picture signal just disappears. Beyond this point, the pulse amplitude steadily decreases as  $R_4$  is reduced. The optimum value for  $R_4$  is slightly lower than the critical value for a V.F. input corresponding to a signal on the tube rather weaker than is ever likely to be required. This will usually be obtained with  $R_4$  about 20 k $\Omega$  and a pulse output of about 80 V will be secured. However, valves and resistor values have a fairly wide tolerance on their characteristics and in some cases some adjustment to the value of  $R_4$  may be needed.

This applies also to  $V_2$ , where the important resistor is  $R_8$ . If  $R_8$  is too high,  $V_2$  will give no output—if it is too low, line pulses will appear in the output as well as frame. The best method of checking is to remove  $V_3$  and connect an oscilloscope to the anode of  $V_2$ , replacing  $R_8$  by a variable resistor.

Starting with a high value for  $R_8$ , no output will be obtained. As  $R_8$  is reduced a critical value will be found at which frame pulses just begin to appear. Further reduction of  $R_8$  results in increased amplitude of frame pulses until another critical value is reached at which the line pulses begin to show between the frame pulses. The optimum value lies between these two, but nearer the second than the first.

When testing without sync pulses, a variation of  $R_{11}$  has a

COMPONENTS

The parts in this list are the ones employed in the original model. Any components of the same electrical specification and suitable physical dimensions can be used.

Capacitors

C <sub>1</sub> , C <sub>5</sub> , C <sub>8</sub> , C <sub>9</sub>	.. 8 μF, electrolytic, 500 V working	.. Dubilier Drilitic	B.R. 850
C <sub>2</sub>	.. 200 pF, mica, 500 V working	.. T.C.C. Type M	
C <sub>3</sub> , C <sub>4</sub> , C <sub>7</sub>	.. 0.1 μF, paper tubular, 500 V	.. T.C.C. Type C.P.	43.5
C <sub>6</sub>	.. 0.05 μF paper tubular, 500 V	.. B.I.	

Resistors

R <sub>1</sub> , R <sub>13</sub> , R <sub>14</sub> , R <sub>15</sub>	.. 1 MΩ, ¼ watt	.. Erie
R <sub>2</sub> , R <sub>4</sub> , R <sub>16</sub>	.. 22 kΩ, ½ watt	.. Erie
R <sub>3</sub> , R <sub>10</sub>	.. 33 kΩ, ½ watt	.. Erie
R <sub>5</sub>	.. 220 kΩ, ¼ watt	.. Erie
R <sub>6</sub> , R <sub>7</sub> , R <sub>9</sub>	.. 47 kΩ, ½ watt	.. Erie
R <sub>8</sub>	.. 15 kΩ, ½ watt	.. Erie
R <sub>11</sub>	.. 100 kΩ, ¼ watt	.. Erie
R <sub>12</sub>	.. 2 MΩ, variable, linear law	.. Reliance Type T.W.
R <sub>17</sub>	.. 47 Ω, ¼ watt	.. Erie
R <sub>18</sub>	.. 5 kΩ, 15 watt	.. Welwyn
R <sub>19</sub>	.. 220 Ω, 1 watt	.. Erie
R <sub>20</sub>	.. 2 kΩ, variable, wire-wound, linear law	.. Reliance Type T.W.

Valves

V <sub>1</sub>	.. EF50	.. Mullard
V <sub>2</sub> , V <sub>3</sub>	.. EF37	.. Mullard
V <sub>4</sub>	.. CL33	.. Mullard

great effect on the frequency of the saw-tooth wave, but when V<sub>3</sub> is synchronized varying R<sub>12</sub> over a wide range has no effect other than to vary the amplitude of the wave somewhat.

The amplitude changes because the pulses see that the generator is regularly triggered, but the rate of discharge of C<sub>6</sub> depends on the value of R<sub>12</sub>. When synchronized the output is always smaller than when running free and of higher frequency.

Details of the power supply will be given later. The + H.T.2 line is nominally 250 V, but can be anything from 240 V to 270 V without affecting the performance appreciably. The + H.T.1 line is also not critical and the voltage is dictated more by the requirements of the line time-base than by the frame. So far as this unit alone is concerned anything over 350 V is satisfactory.

Testing with a 420-volt supply for H.T.1 and 250 V for H.T.2 the cathode of V<sub>4</sub> was at + 6.6 V and the anode current 28 mA. V<sub>3</sub> took 0.4 mA anode current with 100 V at the junction of R<sub>9</sub> and R<sub>10</sub>.

on or off at any required time and may also be used as an alarm. If no suitable programme is available the alarm takes the form of a fixed note, the intensity of which is under the control of a four-position volume switch. The receiver is a superhet (3 valves + rectifier) and is fed by an internal frame aerial. The plastic case measures 12in x 6in x 6½in and the price is £24 3s (purchase tax extra). Makers: E. K. Cole, South-end-on-Sea.

In the new Philips Model 462A a three-valve + rectifier circuit gives reception on short (16.2-52 metres), medium (190-575 metres) and long waves (800-2,000 metres) and the same type of valve (ECH21) is used as frequency-changer and as combined I.F. and A.F. amplifier. The set is housed in a moulded cabinet with projecting translucent tuning scale, and an internal plate aerial is available for local station reception. The price of the Model 462A, which is made by Philips Lamps, Century House, Shaftesbury Avenue, London, W.C.2, is £18 18s, plus £4 1s 4d purchase tax.

An 8-inch permanent magnet loudspeaker fed from a 6V6 output valve giving 4 watts at 10 per cent distortion are features of the new Philco Model A536W table model receiver. This set, which is housed in a birch plywood cabinet measuring 20in x 17in x 8½in with walnut veneer front, employs a four-valve + rectifier superhet circuit and covers long, medium and short waves, the latter 16.67 to 50 metres. The horizontal tuning scale carries station names and is calibrated in Mc/s on the short-wave range. The makers are Philco Radio and Television Corporation of Gt. Britain, Wadsworth Road, Perivale, Greenford, and the price is £19 19s, plus £4 6s 5d purchase tax.

NEW DOMESTIC RECEIVERS

AN unconventional note is struck in the Ekco "Radiotime" in which the dominant feature of the front panel is an electric clock (the loudspeaker radiates from the base of the cabinet). Five medium-wave and one long-wave station are pre-tuned and selected by a rotary switch. The clock mechanism can be set to switch the desired station

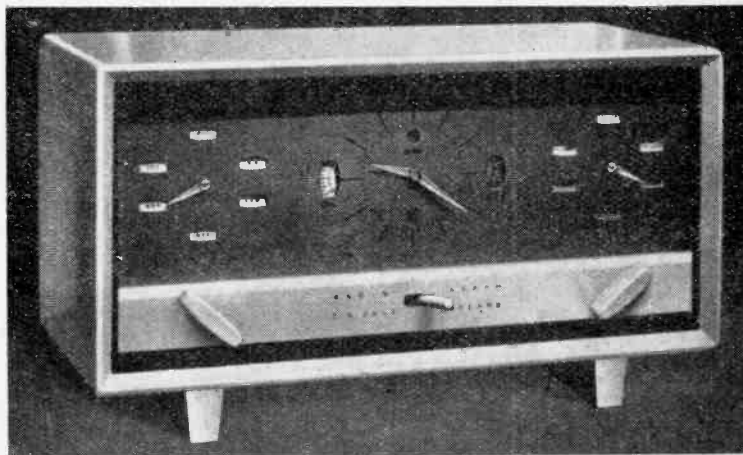

Ekco "Radiotime" set with built-in electric clock switch.

Design Data (13)

# CORRECTED R.C. COUPLING

THE method of determining the value needed for an interstage-coupling capacitor was given in Design Data No. 12 and it was shown that in some cases the value becomes inconveniently large. It is possible to employ a smaller capacitance if additional elements are included in the circuit to produce an inverse distortion.

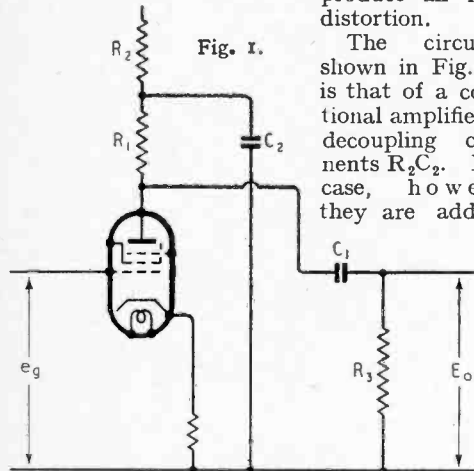

Fig. 1.

The circuit is shown in Fig. 1 and is that of a conventional amplifier with decoupling components  $R_2C_2$ . In this case, however, they are added to

frequency response less and it will normally have a higher leakage resistance.

### Formulae

The basic amplification is

$$A = \frac{E_o}{e_g} = g_m R_1 \dots \dots \dots (1)$$

The pulse response is

$$x = \frac{I}{\alpha - I} [\alpha e^{-t/\alpha T} - e^{-t/T}] \dots \dots (2)$$

where  $t$  is reckoned from the moment of application of the pulse and

$$T = C_2 R_1 = C_1 R_3$$

$$\alpha = R_2 / R_1$$

When  $t/T$  is small, this is very nearly

$$x = 1 - t^2 / 2\alpha T^2 \dots \dots \dots (3)$$

so that

$$T = t / \sqrt{2\alpha(1-x)} \dots \dots \dots (4)$$

### Examples

Suppose an amplifier is needed for a 50-c/s sawtooth wave and that the permissible distortion is only 2 per cent. Let  $R_1 = 10 \text{ k}\Omega$ ,  $R_3 = 0.25 \text{ M}\Omega$  what values are needed for  $C_1$  and  $C_2$  if (a)  $R_2 = 10 \text{ k}\Omega$ , (b)  $R_2 = 20 \text{ k}\Omega$ ?

For 2 per cent distortion, the response at time  $t = 1/50 = 0.02$  second can drop by 0.02 only, so  $x = 0.98$ . From (4)

$$T = 0.02 / \sqrt{2\alpha(0.02)}$$

Case (a)		Case (b)
$\alpha = 1$	$\alpha = 2$	
$T = \frac{0.02}{\sqrt{0.04}} = 0.1$	$T = \frac{0.02}{\sqrt{0.08}} = 0.07$	
$C_1 = \frac{0.1}{2.5 \times 10^5} = 4 \times 10^{-7} \text{ F} = 0.4 \mu\text{F}$	$C_1 = \frac{0.07}{2.5 \times 10^5} = 2.8 \times 10^{-7} \text{ F} = 0.28 \mu\text{F}$	
$C_2 = \frac{0.1}{10^4} = 10^{-5} \text{ F} = 10 \mu\text{F}$	$C_2 = \frac{0.07}{10^4} = 7 \times 10^{-6} \text{ F} = 7 \mu\text{F}$	

provide compensation for the deficiencies of the coupling elements  $C_1R_3$  and not for decoupling<sup>1</sup>. They do provide some decoupling as well, it is true, but very little. By the very nature of the matter, the requirements of compensation and decoupling are opposing, so that if decoupling is needed additional components for this purpose must be provided.

The effectiveness of the compensation obtainable increases with the value of  $R_2$  and this component should always be as high as possible consistent with obtaining proper voltage on the valve. Then, too, compensation is best with a valve having an A.C. resistance high compared with  $R_1$ ; it is better with a pentode than with a triode. For this reason, only the pentode condition is considered in the design formulae. It is also assumed that the grid leak  $R_3$  is large compared with the coupling resistance  $R_1$ , a condition which is nearly always found in practice.

The equations are given only for the case of a pulse input waveform because it is but rarely that compensation is needed with sine-wave inputs. The requirements with such inputs are so much less stringent than with pulses that in most cases there is no difficulty in making the coupling capacitance large enough.

One thing may be worth pointing out. For a given response, the total capacitance  $C_1 + C_2$  is greater with compensation than without, but the coupling capacitance itself is smaller. The advantage of this is that the coupling capacitor has a smaller stray capacitance to earth and so affects the high-

### PORTABLE VALVE AND CIRCUIT TESTER

CURRENT and voltage tests of individual electrodes in valves may be checked under working conditions with the aid of the "Roberts Fault Analyser" marketed by Kerry's (Great Britain), Warton Road, London, E.15, which is a combined valve tester and multi-range test meter. Plug adaptors and cables are provided for all types of valve base and a valve may be transferred to the analyser for test under working conditions without disturbing the receiver chassis. Resistance measurements between individual electrodes and chassis may be made with the aid of the electrode selector switch provided. The voltmeter and ammeter are  $3\frac{1}{4}$ -inch moving coil instruments with full-scale deflections of  $500 \mu\text{A}$ , and a reverse reading switch is provided. There are in all thirty ranges of A.C. and D.C. current and voltage up to 2.5A and 1,000V, and resistance up to  $0.5 \text{ M}\Omega$ , or  $5 \text{ M}\Omega$  with an external battery. The price is £25.

<sup>1</sup> "Transient Response of V.F. Couplings," by W. E. Thomson, *Wireless Engineer*, January 1947, Vol. 24, p. 20.

# Can't get a 25A7G? - then **BRIMARIZE!**

Substitute a BRIMAR 25A6G and a SenTerCel Selenium Rectifier. Alterations are very simple and involve only minor changes of connections and the addition of a SenTerCel Selenium rectifier to replace the rectifier section of the 25A7G. This rectifier is very small and is readily fitted to most chassis. The necessary circuit alterations are shown on the chart below.

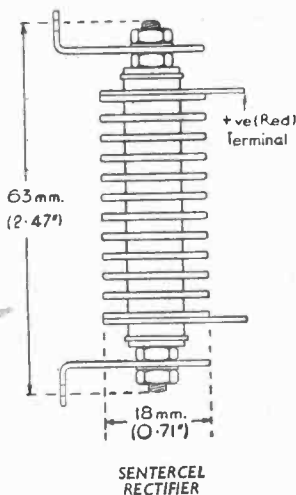
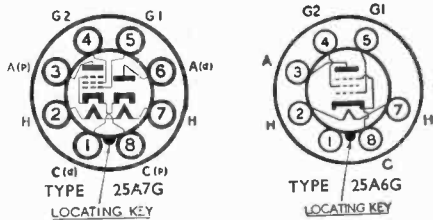

PUNCH HOLES HERE

25A7G

Cut out and file them in the order in which they appear. This column will then give you a quick reference index.

TYPE	CHANGE SOCKET		CHANGE CONNECTIONS		OTHER WORK NECESSARY
	FROM	TO	FROM OLD SOCKET	TO NEW SOCKET	
25A6G	INT/OCTAL.	NO CHANGE	PIN 1 PIN 2 PIN 3 PIN 4 PIN 5 PIN 6 PIN 7 PIN 8	+ VE RECT PIN 2 PIN 3 PIN 4 PIN 5 - VE RECT PIN 7 PIN 8	SenTerCel miniature Selenium Rectifier TYPE SB2 (2½" x ¾" overall) may be fitted to chassis or cabinet. <b>Please Note—Supplies to be obtained through Wholesalers who should now order from S. T. &amp; C. LTD. Brimar Valve Works, Footscray, Kent. LIST PRICE 9/- complete with arms and inclusive of packing &amp; postage.</b>

## BRIMAR

### RADIO VALVES

★ **BRIMARIZE**—verb transitive. Employed by knowing radio dealers in reference to a BRIMAR process by which a new lease of life can be given to sets with obsolete, obsolescent or otherwise unobtainable valves.

STANDARD TELEPHONES AND CABLES LIMITED, FOOTSCRAY, SIDCUP, KENT.

THE NEXT OF THE SERIES WILL DEAL WITH TYPE 70L7GT

2

# Announcing—

## The Automatic

## Polyphonic Radiogram

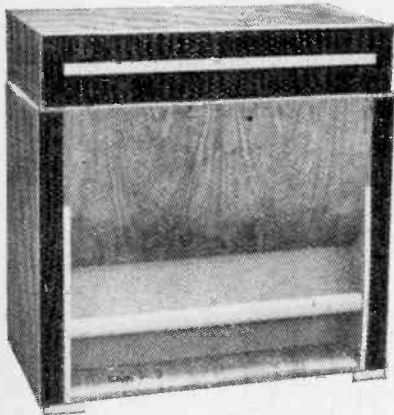

WITH RECORD CHANGER, ESSENTIALLY A QUALITY INSTRUMENT, FREE FROM CABINET "DIALECT," INCORPORATING THE PHASE INVERTER SPEAKER, AND SEVEN VALVE, THREE BAND, TANDEM COUPLED, VARIABLE SELECTIVITY SUPER-HET CHASSIS, WITH PARAPHASE TRIODE OUTPUT.

**PRICE . . . £82-10 plus Purchase Tax**

NON AUTOMATIC MODEL, IS NOW AVAILABLE WITH PLAIN TURNTABLE, AND THE LATEST TYPE CABINET, WHICH IS EVEN MORE ATTRACTIVE, AT THE ORIGINAL

**PRICE . . . £67-10 plus Purchase Tax**

DEMONSTRATIONS CAN BE ARRANGED

at the following Agents:

### LONDON

Wallace Heaton

G. E. Samways Ltd., Hazel Grove

### SURREY

West End Radio, Farnham

Weybridge Radio Electric Co.

### WALES

Sound Ltd., Cardiff

### SHEFFIELD

Needham Engineering Co., Ltd.

### JERSEY, C.I.

Sound Services, St. Helier

### LEEDS

Valiance & Davidson, Ltd. (& branches)

### I. O. W.

C. C. Clark & Sons, Sandown

### NORWICH

Pank's Radio

### NEWQUAY

C. C. Gerry

### BRISTOL

Merrionts, Ltd.

### BARNSTAPLE

B. Smith

### DERBY

Dalton & Sons, Ltd.

### READING

Barnes & Avis

### EDINBURGH

Precision Services, Ltd.

### ANDOVER

Thomas Lynn

# SOUND SALES Ltd.

57 St. Martin's Lane, W.C.2

Works: Farnham Surrey — Farnham 6461

Phone: TEM. 4284

**WALTER CONDENSERS  
ARE MADE FOR**



**WALTER  
INSTRUMENTS LTD.**

GARTH RD., LOWER MORDEN, SURREY  
DERWENT 4421. Grams: WALINST, MORDEN, SURREY

C. R. Casson 7a



**Welwyn**

carbon resistor

WELWYN ELECTRICAL LABORATORIES LTD.  
Welwyn Garden City, Herts.

Telephone: Welwyn Garden 3816-8

Resistors produced by the cracked carbon process remain stable to  $\pm 1\%$  of initial value.

★ Tolerances  $\pm 1\%$   
 $\pm 2\%$   $\pm 5\%$

Low temperature co-efficient.

# NOISE FACTOR

## 3.—Design of Receivers or Amplifiers for Minimum Noise Factor

**I**N this concluding instalment the design and relative performance of various kinds of input stage for R.F. and I.F. amplifiers will be examined.

To understand the principles of input circuit design for minimum noise factor it is necessary to form a clear picture of the various noise sources and the circuit quantities which determine their effect in relation to the wanted signal. This may be done by means of a simple equivalent circuit such as that shown in Fig. 1.

The aerial or other source of signal is usually coupled to the first valve *via* some network consisting of at least one circuit tuned to resonance; this acts as a transformer, and the aerial therefore appears to the valve as a resistance having some value  $R_A$  which depends on the transformer ratio. If  $E$  is the signal voltage appearing across  $R_A$ , then as explained in the first part of this article, the available signal power from the aerial is  $E^2/4R_A$ ; this is independent of the transformer ratio, so that we are at liberty, within practical limits, to alter the coupling between the aerial and the tuned circuit to obtain any preferred value of  $R_A$ . Any number of purely reactive elements may be introduced into the coupling network, and so long as resonance is maintained the source of signal can be pictured as a generator connected between grid and cathode of the first valve,

having an internal resistance  $R_A$  and providing either a constant available signal power  $P_s = E^2/4R_A$  or an open circuit signal voltage  $E = \sqrt{4R_A P_s}$ . It will be recalled that the definition of noise factor assumes a source of signal at room

temperature  $T$ , so that the available noise power from it is  $KT B$ , where  $K$  = Boltzmann's constant and  $B$  = energy bandwidth, and its open circuit noise voltage is

$\sqrt{4KT B R_A}$ . The source, as seen by the first valve, can therefore be fully represented by the portion of Fig. 1 to the left of the dotted line. The right-hand part of this equivalent circuit is required to account for valve and circuit noise and relate them to the aerial noise and signal in such a way that the signal/noise ratio at the terminals AB corresponds to the signal/noise ratio as fed to the second stage.

The input circuit inevitably possesses a certain amount of resistance; the simplest and most usual case is that of a single resonant circuit, and if  $R_c$  is its impedance as viewed by the valve, the effect of this on the signal is visualised by regarding  $R_c$  as a load connected in parallel with the source of signal. In addition,  $R_c$  must be regarded as a generator of thermal noise having an internal impedance  $R_c$  and an open circuit voltage equal to

$$\sqrt{4 K n T B R_c}$$

Both of these effects are accurately represented in Fig. 1. For more complicated input circuits it is possible to deduce an equivalent value for  $R_c$  to represent all the losses, and the reasoning which follows is not materially affected.

It will be noticed that a temperature  $nT$  has been assigned to  $R_c$ ; this is of course room temperature in the case of circuit losses, but as explained later, it is possible to allow for transit-time losses at high frequencies by including them in  $R_c$

and assigning to  $R_c$  a temperature greater than room temperature.

Data on valve shot noise is usually provided in the form of equivalent noise resistance (E.N.R.). This is not an actual resistance, but a mathematical device which happens to be convenient, and the term "resistance" is in some ways un-

fortunate; the concept may be arrived at by imagining a generator of voltage  $E_n$  applied between grid and cathode to simulate the effect of valve noise, then quite arbitrarily writing  $\sqrt{4KT B R_n} = E_n$  and calling  $R_n$  the valve noise resistance. A particular virtue of this trick for our purpose here is that it enables all the different sources of noise to be described in similar language. The physical mechanism of valve noise is best appreciated by forgetting about E.N.R. and picturing the flow of electrons from cathode to anode; if the anode current is constant, the *average* number of electrons hitting the anode in any given unit of time is fixed, but likening the electron stream to a hail of individual particles or "shot," it is evident from the laws of chance that there will be some slight variation in the number of electrons arriving in equal intervals of time. The shorter the intervals which the receiver is capable of investigating (i.e. the wider its bandwidth) the greater the randomness or "noise." From this physical picture, ignoring for the moment the possibility of feedback, it is clear that the valve noise output is independent of the resistance ( $R_A$  in parallel with  $R_c$ ) between grid and cathode, and therefore requires to be represented as shown in Fig. 1.

In the case of pentodes the random element in the sharing of current between screen and anode is additional to the normal shot effect. This is particularly harmful on account of the inverse feed-

By L. A. MOXON,  
B.Sc., A.M.I.E.E.

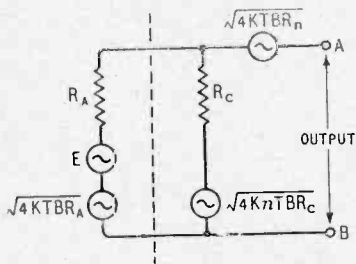

Fig. 1. Simple equivalent circuit of input from aerial.

**Noise Factor—**

back in the cathode lead which is usual at high frequencies. Since the total cathode current is unaffected by fluctuations in the partition of current between anode and screen, cathode feedback has no effect on partition noise, although it reduces the signal,

Splitting  $R_c$  into two parallel components, coil losses  $R_e$  and transit-time loss  $R_t$ , it can be shown that the "temperature" to be assigned to  $R_c$  is given by  $\frac{R_t + 5R_e}{R_t + R_e} T$ , say,  $nT$ .

No account has been taken in these equivalent circuits of noise

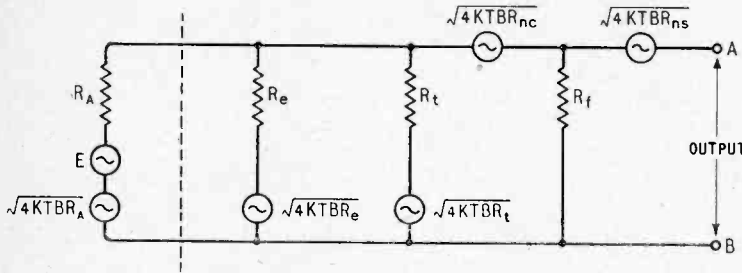

Fig. 2. Equivalent input circuit for pentode showing components of valve noise.

expected, and is obtained, by eliminating the screen altogether, i.e. by using a triode. A further advantage of the triode is that signal-to-noise ratio is not affected by feedback so long as there is adequate stage gain. The difficulty in using triodes due to positive feedback through the grid-anode capacity has been successfully tackled both by earthed-grid operation and by neutralization.

The theoretical analysis which follows is confined to Fig. 1, because the difficulty of analysing valve input impedance into transit time and feedback components usually makes it impossible to apply Fig. 2 in practice. In the case of triodes  $R_f$  can be ignored because in the absence of  $R_{ns}$  it has no effect on signal-to-noise ratio, and in the case of pentodes it has been found that taking  $n = 1$  or 2 and using  $R_c$  to represent the total loss— $R_e$ ,  $R_t$ , and  $R_f$  in parallel—gives a close enough approximation to the truth unless  $R_f$  is very small.

**Calculation of Noise Factor**

Referring to Fig. 1, the noise generator of voltage  $\sqrt{4KTBR_A}$  produces a voltage

$$\frac{R_c}{R_A + R_c} \cdot \sqrt{4KTBR_A}$$

at the grid of the valve, and similarly the voltage  $\sqrt{4KnTBR_c}$

becomes  $\frac{R_A}{R_A + R_c} \cdot \sqrt{4KnTBR_c}$  at the grid. In addition there is the valve noise voltage  $\sqrt{4KTBR_n}$ . The signal voltage at the grid is  $\frac{E R_c}{R_A + R_c}$ . The ratio S of signal-

to-noise power available at AB is the same as the ratio of (signal

volts)<sup>2</sup> to (noise volts)<sup>2</sup>, and the total (noise volts)<sup>2</sup> is found in the usual way by adding the squares of the individual voltages listed

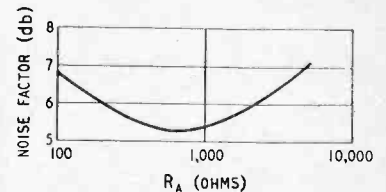

Fig. 3. Variation of noise factor with  $R_A$  for  $R_c = 1,000 \Omega$  and  $R_n = 700 \Omega$ .

to (noise volts)<sup>2</sup>, and the total (noise volts)<sup>2</sup> is found in the usual way by adding the squares of the individual voltages listed

together with the other sources of noise; it is therefore necessary, if cathode feedback is present, to split the E.N.R. of a pentode into two components, cathode E.N.R. ( $R_{nc}$ ) and screen E.N.R. ( $R_{ns}$ ), as shown in Fig. 2, and represent the feedback by the noiseless resistance  $R_f$ , or, in other words, as a reducing agent acting on all the voltages shown to the left of it.

At sufficiently high frequencies an appreciable change of grid voltage takes place during the time required for an electron to travel from cathode to grid, and the resulting disturbance of the electron distribution in the cathode-grid and grid-anode spaces induces an external current in the grid-cathode circuit. This current has a component in phase with the applied voltage, which constitutes additional loading of the input circuit, and the effect of this on the signal, and on the noise voltages already discussed, is accounted for by an appropriate reduction in the value of  $R_c$ . Since there is a random element in this effect on account of its electronic nature, it constitutes an additional source of noise, and North and Ferris<sup>1</sup> have shown that it is equivalent to that obtained by assigning a noise temperature of five times room temperature to the transit-time loss resistance.

originating in stages after the first. If this is appreciable each stage may be treated separately in the first instance and the results combined by means of equation (1) in Part I, namely,  $N_R = N_1 + \frac{N_2 - 1}{G_1} + \frac{N_3 - 1}{G_1 G_2} + \dots$  etc.<sup>2</sup>

It is unusual for terms after the second to be significant.

**Pentodes versus Triodes**

It is common practice to use a pentode as the first valve in receivers. Better noise factor is obtained with high-slope pentodes (such as the Mullard EF50 and Mazda SP41) than with low-slope pentodes because signal power output increases as the square of the slope, whereas as long as the anode and screen currents are constant, shot noise is unchanged. However, even high-slope pentodes usually have an E.N.R. in the region of 1,500 ohms, contrasting with 300-500 ohms for typical high-slope triodes. This difference is entirely due to screen noise, and in the Mullard RL7, now known as the EF54, the screen current and therefore the screen noise has been reduced by a special alignment of grids, thereby achieving an E.N.R. of 700 ohms or so; even of this, over 400 ohms is screen noise, so that considerable further improvement is to be

<sup>1</sup> "Fluctuation Induced in Vacuum Tube Grids at High Frequencies." Proc. I.R.E., Vol. 29, p. 49 (1941).

<sup>2</sup> It is regretted that the denominator of the third term was inadvertently given as  $G_4$  instead of  $G_1 G_2$  in Part I.



above. A few lines of elementary but rather tedious algebra lead to the expression

$$S = \frac{E^2}{4KTBR_A [1 + nR_A/R_c + R_n/R_A (1 + R_A/R_c)^2]} \dots (8)$$

Now  $E^2/4KTBR_A$  is the ratio of available signal-to-noise power for the aerial alone and for the perfect receiver

$S = 1$  when  $E^2 = 4KTBR_A$ . The expression inside the brackets is therefore the number of times by which the signal power  $\frac{E^2}{4R_A}$  available from the aerial must exceed  $KTB$  in order to make  $S = 1$ ; this is the noise factor  $N_r$  as defined in Part I and the required expression for noise factor is therefore

$$N_r = 1 + nR_A/R_c + R_n/R_A (1 + R_A/R_c)^2 \dots (9)$$

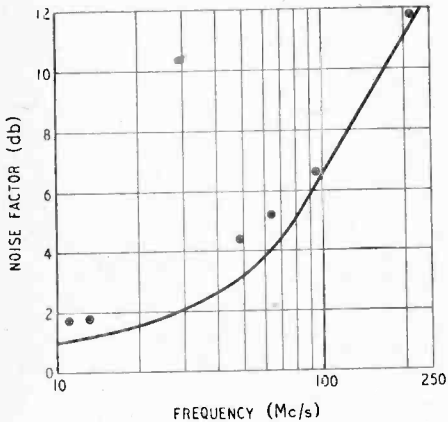

Fig. 4. Variation of noise factor with frequency for a pentode (EF54). Full line calculated from valve data, neglecting coil losses. Experimental observations indicated by points.

**Optimum Design**

From equation (9),  $N_r$  has a minimum value when

$R_A = R_c \sqrt{\frac{R_n}{R_n + nR_c}}$ , and since the condition for maximum gain is obtained (in the absence of feedback) when  $R_A = R_c$ , adjustment of the input circuit for maximum gain *must* give the wrong answer—although if  $R_n$  is larger than  $nR_c$  the error is small. The optimum is not very critical, as illustrated in Fig. 3 for a typical set of conditions, and can be found easily by trial and error.

Substituting the optimum condition in equation (9) we get  $N_r$  (minimum) =  $1 + 2R_n/R_c + 2\sqrt{R_n/R_c(n + R_n/R_c)}$  .. (10)

The aim is therefore to make  $R_n/R_c$  as small as possible.

The valve noise resistance  $R_n$

may be roughly estimated for valves with oxide-coated cathodes from the following expression, in which the first term represents cathode noise.<sup>3</sup> The second term is screen noise and disappears in the case of triodes.  $R_n$  is in ohms,  $I_s$  and  $I_p$  are the screen and anode currents in milliamps and  $G_m$  is the mutual conductance in milliamps per volt.

$$R_n = \frac{A}{G_m} \times 10^3 + \frac{20}{G_m^2} \cdot \frac{I_s I_p}{I_s + I_p} \times 10^3 \dots (11)$$

A depends on cathode tempera-

ture and valve geometry, and is of the order of 2.2 for oxide-coated cathodes. The resistance  $R_c$  consists partly of coil losses (this part of it being, as a rule, roughly proportional to wavelength), and valve input losses which increase as the square of the frequency. For the EF50,

ture, and partly, since it includes, the feedback resistance, at zero noise temperature. The errors in calculating the optimum value of  $R_A$  are likely to be rather more appreciable than the errors in predicting noise factor, and in practice it is best to find the best value of  $R_A$  by trial and error taking the calculated value as a rough guide.

effect partly at room temperature' partly at five times room tempera-

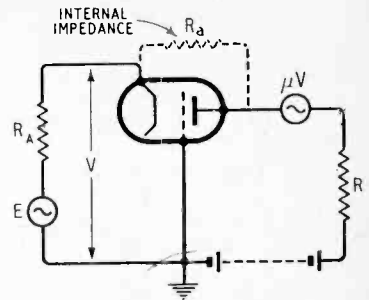

Fig. 5. Basic circuit of earthed-grid triode.

ture, and partly, since it includes, the feedback resistance, at zero noise temperature. The errors in calculating the optimum value of  $R_A$  are likely to be rather more appreciable than the errors in predicting noise factor, and in practice it is best to find the best value of  $R_A$  by trial and error taking the calculated value as a rough guide.

In the case of acorn pentodes the values obtained for  $R_n$  and  $R_c$  are *both* about ten times the values for the EF54, and the performance obtained is accordingly very similar.

**Bandwidth Considerations**

In the absence of  $R_f$ , the bandwidth of the input circuit is determined by  $R_A$  and  $R_c$  in parallel and by the input capacity  $C$ , and may be expressed as follows:—

$$B_{in} = \frac{R_A + R_c}{2\pi C R_A R_c} \dots (12)$$

There is a minimum practicable value for  $C$ , and therefore if  $R_A$  is chosen for minimum noise factor, a maximum value for  $B_{in}$  is automatically fixed. Now  $B_{in}$  must obviously be made greater than the required overall bandwidth of the receiver, and for many radar or television purposes it may be necessary in consequence to depart from the minimum noise factor condition. If  $B_{in}$  is increased by reducing  $R_A$  considerable departure from the optimum condition is possible without serious loss of performance but the not uncommon practice

the input loss resistance is of the order of  $10^7/(\text{frequency})^2$  ohms, and for the EF54 the figure is about 50 per cent greater.

Fig. 4 shows the variation with frequency of the minimum noise factor obtainable with the EF54 as calculated from equation (9) from valve data, neglecting coil losses and putting  $n = 1$ , together with a number of measured points obtained with typical circuits. The discrepancy between theory and experiment at the lower frequencies can be accounted for by coil losses.

By putting  $n = 1$  or 2, the errors inherent in applying the circuit of Fig. 1 to pentodes tend to cancel each other since  $R_c$  is in

<sup>3</sup> For bibliography, see W. B. Lewis, "Radio Receivers," J.I.E.E., Vol. 93, Part IIIA, No. 1.

**Noise Factor—**

of increasing  $B_{in}$  by connecting a damping resistance across the input circuit (i.e., reducing  $R_c$ ) has a much more serious effect, as can be appreciated from inspection of equations (9) and (10)

For other applications, such as communication receivers, a lower value of  $B_{in}$  may be required in order to improve preselection. In this case  $R_A$  may be increased slightly above the optimum value, but any further reduction of  $B_{in}$  should be effected by increasing  $C$  whilst keeping the input circuit losses as low as practicable.

With very wide bandwidths the noise factor increases for two reasons. In addition to the necessity of departing from the optimum value of  $R_A$ , the stage gain drops and noise from the second or even later stages ultimately becomes appreciable. An estimate of this effect may be made with the aid of equation (1).

**Triode V.H.F. Amplifiers**

*The Earthed-Grid Triode.* — Triode amplifiers have been developed for radar, in which the signal is applied to the cathode and the grid earthed so that it acts as a shield between anode and cathode as demonstrated in Fig. 5. With suitable triodes this reduces the anode-cathode capacity to a low value, but inverse feedback from anode to cathode *via* the internal

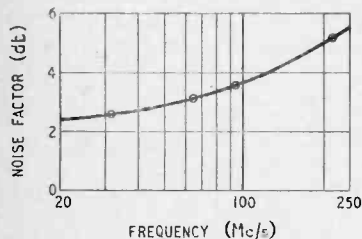

Fig. 6. Measured noise factor of CV53 earthed-grid triode.

resistance of the valve is an inherent feature. This feedback is such as to reduce equally all fluctuations of anode current whether due to shot effect, thermal noise, applied signal or any other cause, and can be represented in the equivalent circuit by attributing a noiseless input impedance  $R_f$  to the valve. From elementary valve theory, a small change  $v$  of grid-

cathode voltage produces an anode current change  $i$  which is equal to  $v(\mu + 1)/(R + R_a)$  where  $R$  is the anode load and  $R_a$  the internal impedance of the valve. In the absence of grid current, anode and cathode current are the same so that  $R_f$  is equal to  $v/i$ , or in other words to  $(R + R_a)/(\mu + 1)$ .  $R_f$  may be regarded as connected

S.26A (or CV53) which use the disc seal type of construction and have the following constants:—  
 $R_n \approx 430$  ohms;  $\mu = 100$ ;  $R_a = 20,000$  ohms; anode-grid capacitance = 1.7 pF; anode-cathode capacitance = 0.035pF; cathode-grid capacitance = 4 pF.

Typical experimental figures for the variation of CV53 performance

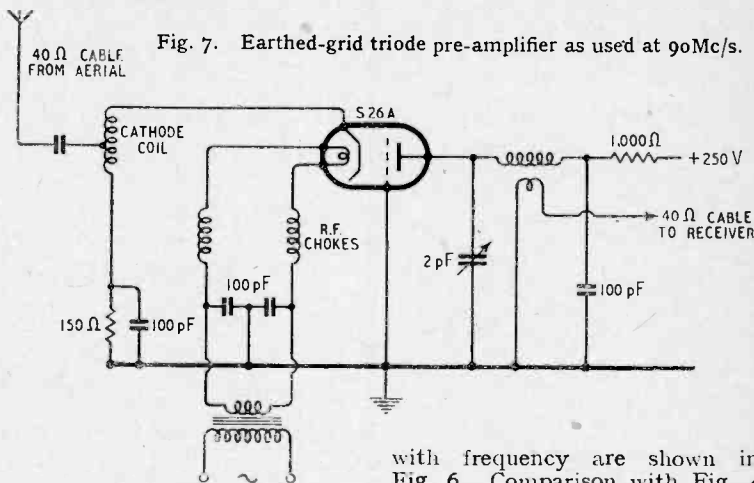

Fig. 7. Earthed-grid triode pre-amplifier as used at 90Mc/s.

across the terminals AB of Fig. 1.

The effect of the feedback is to reduce the gain, and greatly to increase the input circuit bandwidth, but since it does *not* alter the relative magnitudes of signal and noise voltages, it has no effect on noise factor or on the design of the input circuit, except as an indirect consequence of the gain reduction when second-stage noise is appreciable. In this latter case the optimum value of  $R_A$  tends to be modified in the direction of the "power match" condition.

It might be thought that the widening of the input circuit would make the earthed-grid triode specially suitable for very wide-band amplifiers, but this is not the case as the output load  $R$ , and therefore the effective stage gain, must be kept small in order to achieve a wide pass-band. This means that second stage noise is appreciable and in consequence for bandwidths of the order of 20 Mc/s the earthed-grid triode has been found little, if any, better than a pentode.

The first earthed-grid triodes to be designed for low noise R.F. amplifiers were the S.25A and

with frequency are shown in Fig. 6. Comparison with Fig. 4 shows the substantial improvement obtainable by using a triode at the higher frequencies.

Fig. 7 shows the circuit arrangement of a typical pre-amplifier using the CV53, which was developed for connection in front of a 200 Mc/s radar receiver with a pentode R.F. stage, and improved its noise factor by 6 db, with a power gain of about 17 db.

Other triodes designed for earthed-grid operation include the RL37 (pressed-glass base) and the CV139 (miniature base). These valves are capable of giving comparable performance to the CV53, but necessarily have rather higher capacities, and therefore reduced gain for a given bandwidth; so that when using a CV139 or RL37 amplifier in front of a relatively noisy device such as the average mixer, it is usually advisable to use two stages.

*The Neutralized Triode.*—Neutralization is one of the oldest devices for obtaining satisfactory R.F. amplification with triodes, but its application to the reduction of noise factor at metre wavelengths is a recent development of American origin. It has

been found to offer considerable advantage over the earthed-grid triode for very wide bandwidths on account of the greater gain, and one of the methods of neutralization which have been employed is illustrated in Fig. 8. Neutralization is effected by tuning the anode-grid capacity to resonance with a suitable inductance. The low input impedance of the earthed-grid second stage provides adequate damping of the first stage anode circuit without introducing additional thermal noise.

For narrow bandwidths at the higher frequencies the performance of triodes is determined mainly by the transit-time loss. The use of neutralization, by increasing the possible gain, confers an additional degree of freedom on the valve and circuit designer alike and an appreciable improvement (about 1½ db at 45 Mc/s) relative to the CV53 has been claimed for the American 6AK5 pentode connected as a neutralized triode for narrow bandwidths. At very wide bandwidths, somewhat greater improvements are obtainable and noise factors of 4 or 5 db can be realised with neutralised triodes at 20 Mc/s bandwidth compared with 7 or 8 db for pentodes.  $R_A$  is then small compared with  $R_c$ , so that (9) reduces to  $N_r \approx 1 + R_n/R_A$  and (12) to  $B_{in} \approx 1/2\pi C R_A$ . Combining these results,  $N_r \approx 1 + 2\pi C B_{in} R_n$  .. (14)  $C$  is the total effective input capacity and includes the "Miller effect" so that the lower  $R_n$  of a triode may be offset by the higher  $C$ . With suitable triodes this is not serious.

Some examples of alternative forms of simple aerial-to-valve

coupling networks are illustrated in Fig. 9. Main factors affecting

in all the above cases except (c) and (e) when it is somewhat smaller.

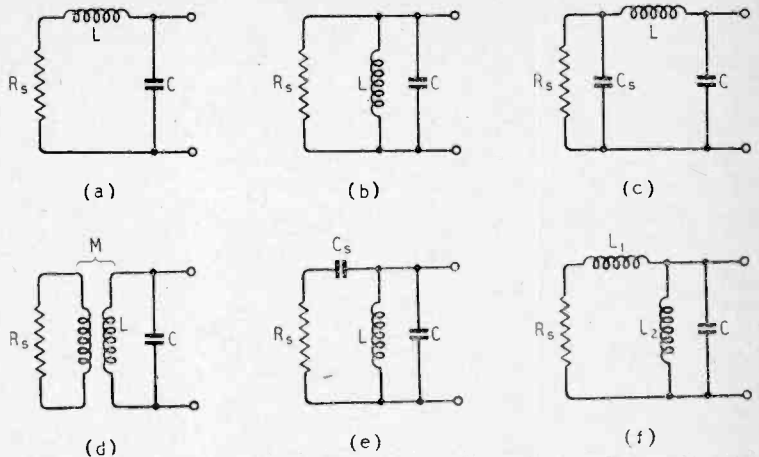

Fig. 9. Alternative forms of aerial-to-valve coupling.

the choice of circuit include the bandwidth required, impedance of the aerial, mixer or other source of signal and probable variations of source impedance. The value of  $R_A$  in terms of the actual source impedance  $R_s$  is shown in the following table:—

Fig 9	$R_A$
(a)	$\omega^2 L^2/R_s$
(b)	$R_s$
(c)	$\frac{C_s^2}{C^2} \left( R_s + \frac{1}{\omega^2 C_s^2 R_s} \right)$
(d)	$L^2 R_s / M^2$
(e)	$1 / \omega^2 C_s^2 R$
(f)	$\omega^2 L_1^2 / R_s$

The input circuit bandwidth (with no feedback) is approximately as given by equation (12)

Examples (a) and (b) are only usable when  $R_s$  is (or can be made) approximately the right value. In other cases it is possible to cover a relatively wide range of requirements. Example (c) is interesting because when  $R_s = 1/\omega C_s$  the value of  $R_A$  is relatively insensitive to the value of  $R_s$ , and therefore both the noise factor and bandwidth are nearly independent of  $R_s$ , but a disadvantage is the dependence of input circuit tuning on the value of  $R_s$ .

### Centimetre and Decimetre Wavelengths

The previous paragraphs in this section are applicable primarily to frequencies up to the order of 300 Mc/s. In microwave technique the first amplifying valve is normally preceded by a crystal mixer, and the noise factor is given by equation (2), Part I, i.e.,

$$N_r = L (T_r + N_2 - 1)$$

The designers' object therefore is to achieve the lowest possible values of  $L$ ,  $T_r$  and  $N_2$ , but the conversion loss ( $L$ ) and the N.T.R. ( $T_r$ ) are mainly in the hands of the crystal manufacturers leaving only the I.F. noise factor  $N_2$  to the receiver designer. At 10 cms., the best values achieved for  $L$ ,  $T_r$ , and  $N$  are respectively about 3.0, 1.0 and 1.6, giving a noise factor of 4.8 times or 7 db.

When R.F. stages are employed at decimetre wavelengths the

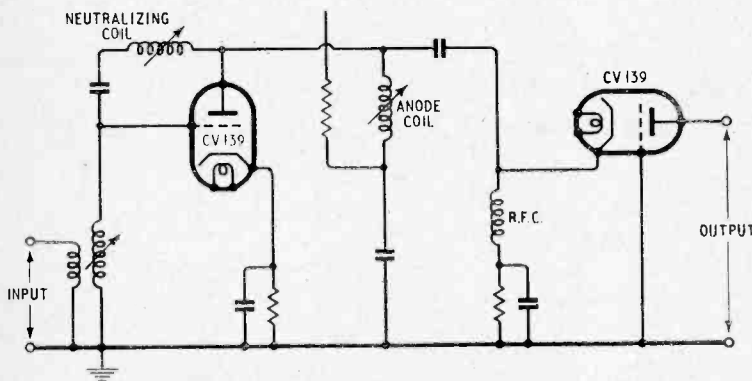

Fig. 8. Circuit of neutralized triode R.F. amplifier.

**Noise Factor—**

theory becomes much more complicated on account of transit time. It has been assumed, for example, that the various noise components are completely random with respect to one another. This is not true of the noise associated with the transit-time input loss, but at low frequencies and with a resistive input circuit, this noise is in phase quadrature with the shot noise and can be treated in the same way as if it was random, although a slight improvement in noise factor is sometimes possible by detuning the input circuit, since this can alter the phase of the induced noise and bring about some degree of noise cancellation. At very high frequencies involving large transit angles, the assumption of phase quadrature breaks down completely.

**Conclusion**

The importance of designing for good noise factor is most apparent when the aerial noise temperature

is low and range is limited by internal rather than external noise.

In the region from 70 Mc/s or so down to the frequency at which the ionosphere becomes an effective absorber of radiation, the noise from the Milky Way (and sometimes solar noise) is so great that little advantage results from striving after the last few db of receiver perfection. The amateur working at 60 Mc/s for example, will find a 10 db noise factor just as good as a 4 db noise factor for normal working, but under "freak" conditions when long-distance communication is possible the noise level should be lower and the 6 db difference may well be vital. At 30 or 40 metres and upwards, interference and atmospheric rather than receiver noise are usually the limiting considerations.

The reader interested in a more detailed study of this subject is referred to a paper by the author entitled, "The Noise Characteristics of Radar Receivers," published in Part IIIA of the *Journal I.E.E.*

**SHORT-WAVE CONDITIONS***Expectations for May*

By T. W. BENNINGTON (Engineering Division, B.B.C.)

**D**URING March maximum usable frequencies for this latitude decreased very slightly during the day and increased considerably during the night. These are the normal seasonal variations, which should now continue towards midsummer.

A large amount of ionosphere storminess occurred during the month, much of it connected, no doubt, with a giant sunspot group which crossed the sun's disc between March 3rd and 17th and was on the central meridian on March 10th. On the 3rd, during one of the ionosphere storms, the Aurora Borealis was seen in Scotland and Northern England. Though it is difficult, because of their number, to separate, in some cases, one ionosphere storm from another, the following were the periods of most disturbance: 2nd-4th, 8th-9th, 11th-17th, 22nd-23rd, and 26th-31st.

**Forecast.**—Daytime M.U.F.s for most transmission paths should continue to decrease during May, and the peak M.U.F.s should be considerably lower than during April.

Night-time M.U.F.s should, on the other hand, be considerably higher than during the previous month. Moderately high frequencies will remain of use for considerably longer periods than during April, because of the longer duration of daylight at this end of the circuits. The net result is that during May there will be less change in the working frequencies as between night and day over most transmission paths than is the case at present.

Except on southerly transmission paths communication on exceptionally high frequencies (like the 28-Mc/s band) will be relatively infrequent, and, in particular, this frequency is not likely to be of much use for transatlantic communication during May. Relatively high frequencies will remain usable during the night and 11 Mc/s is about the lowest that will be really necessary at any time.

For distances up to about 1,800 miles transmission during the daytime will be controlled largely by the E and F, layers, and for these

distances daytime as well as night-time working frequencies should be higher than during April. Sporadic E should increase considerably in the frequency of its occurrence during the month, and transmission by way of this medium up to about 1,400 miles may be frequently possible on exceptionally high frequencies.

Below are given, in terms of the broadcast bands, the working frequencies which should be regularly usable during May for four long-distance circuits running in different directions from this country. In addition, a figure in brackets is given for the use of those whose primary interest is the exploitation of certain frequency bands, and this indicates the highest frequency likely to be usable for about 25 per cent of the time during the month for communication by way of the regular layers:—

<b>Montreal :</b>	0000	15 Mc/s	(22 Mc/s)
	0300	11 "	(19 " )
	0900	15 "	(23 " )
	1200	17 "	(26 " )
<b>Buenos Aires :</b>	0000	17 Mc/s	(24 Mc/s)
	0300	15 "	(22 " )
	0700	11 "	(20 " )
	0900	17 "	(25 " )
	1000	21 "	(30 " )
<b>Cape Town :</b>	0000	17 Mc/s	(24 Mc/s)
	0200	15 "	(21 " )
	0500	17 "	(25 " )
	0700	21 "	(30 " )
	1000	26 "	(37 " )
	1900	21 "	(30 " )
<b>Chungking :</b>	0000	15 Mc/s	(20 Mc/s)
	0100	11 "	(19 " )
	0300	15 "	(21 " )
	0600	17 "	(24 " )
	2000	15 "	(21 " )

During May ionosphere storms are not usually prevalent, nor are the effects of those which do occur usually particularly disastrous to radio communication. At the time of writing it would appear that storms are more likely to occur during the periods 2nd-3rd, 6th-8th, 16th-17th, 23rd-25th and 29th-30th, than on the other days of the month.

**VALVE STANDARDIZATION**

**D**ETAILS of the new 8-pin base of pressed glass construction introduced by the British Valve Manufacturers' Association appeared in our November, 1946, issue. Since then an alternative version of the Type B8A base has been agreed; the centre spigot may be omitted in some cases, though it will be necessary to continue to provide a centre hole in all B8A valveholders in order that they may accommodate either type. The raised boss on the side of the valve base will continue to be used in both types to locate the valve pins correctly in the base.

# BELLING-LEE QUIZ (No. II)

Answers to questions we are often asked by letter and telephone

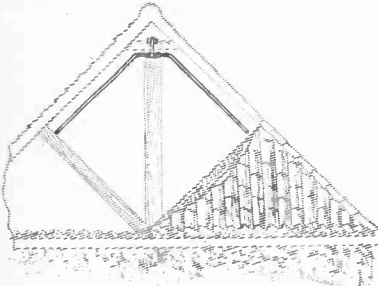

† Shows the Belling & Lee inverted "V" television aerial mounted in the attic.

**Question 40:** Why the funny shape? (asked many times at the components exhibition).

**Answer 40:** The purpose behind its design was the production of an aerial somewhat more compact than the orthodox dipole, and one that could be erected in the loft of an average house and give good results in such location. This aim has been achieved within certain limits.

The inverted "V" form lends itself to erection in the attic or loft of the average house, high up under the ridge, well away from plumbing and conduits. Installation engineers appreciate the impracticability of installing a normal dipole in such locations, while the indoor installation of a dipole and reflector array is well nigh impossible.

It should only be used under conditions of high field strength, and it is suggested that up to ten miles for outdoor use and five miles for attic use should be taken as a general guide, for distance from transmission stations.

Even when using a simple dipole many television installations require the use of resistive attenuations to reduce the strength of the incoming signal to the appropriate level.

## A new television aerial, both interesting to look at and efficient to use

With this new aerial such attenuation is not likely to be necessary, yet the polar diagram shows that the aerial has the advantage of being directional, with a very high ratio of maximum/minimum pickup. This feature is most useful in removing unwanted reflection "ghosts" from gas holders, tall steel structures, etc., and for the improvement of signal-to-noise ratio in localities where interference is troublesome, particularly from electronic heating apparatus, e.g., diathermy. Hitherto, the only answer has been the use of a relatively expensive dipole and reflector array even in districts where the use of such an aerial necessitated the generous application of resistive attenuation. The effective band width is somewhat greater than that of the conventional type, and thus takes full advantage of the increased band width now being transmitted on the vision channel.

Below we show polar diagrams of each of our television aerials. That in the centre applies to the new inverted "V."

1. L502 and L392 series comprising dipole and reflector. Gain in maximum position relative to a simple dipole (Fig. 3) + 6 db. Vision shown solid, sound shown dotted.
2. Inverted "V" compressed aerial described above. L605, L606. Gain in maximum position relative to a simple dipole—6 db. Sound and vision.
3. Simple dipole sound and vision.

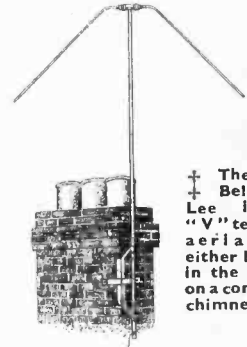

† The new Belling & Lee inverted "V" television aerial may either be fitted in the attic or on a convenient chimney.

As the methods of mounting naturally differ considerably two models are being made available.

† L. 605. Inverted "V" type dipole television aerial. Attic model with hanging bracket. £2 12s. 6d.

† L. 606. Inverted "V" type dipole television aerial. Outdoor model complete with 9ft pole and requisite chimney lashing brackets. £4 19s. 0d.

## British Industries Fair

We will be exhibiting in the Hall of Radio and Music (Empire Hall Olympia) **Stand No. C 1540.**

It will be our aim to have a responsible engineer on the stand at all times and to be able to answer any reasonable, appropriate questions which visitors may wish to ask. Please do come and meet us.

We will show a full range of our products—Aerials—Plugs and Sockets, Terminals, Fuses and Fuseholders Thermal Delay Switches, Valveholder, and H.F. Interference Suppressors.

We hope to have some interesting practical demonstrations, e.g., to show the application of thermal delay switches to electric motors, etc.

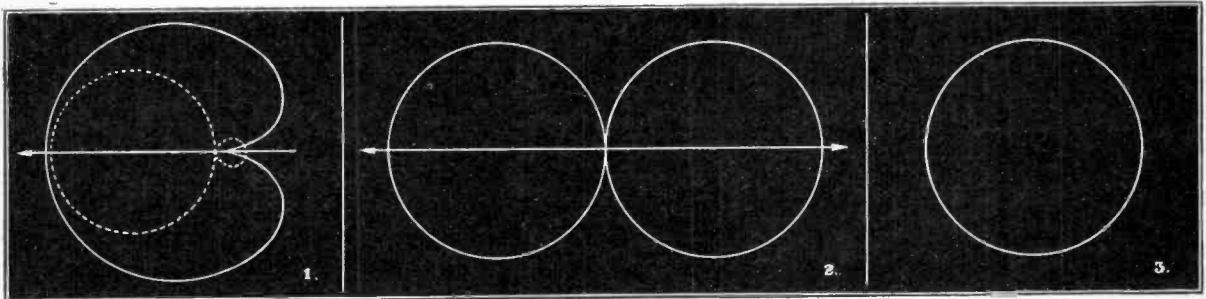

**BELLING & LEE LTD**  
CAMBRIDGE ARTERIAL ROAD, ENFIELD, MIDD'X

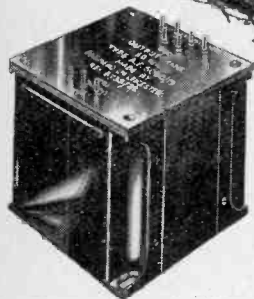

EVERY  
MAN  
FOR  
HIMSELF . . .

Well, maybe we could adopt that policy of slapping Transformers together and churning them out as fast as possible irrespective of quality - you know, bash the next JAM chap for all he is worth, let the future take care of itself.

But we think that attitude is wrong and in any case a Parmeko job always has been made up to a standard and not down to a price.

We realise that the success of our business depends upon the success of your business, if you go bust then we go bust because you don't buy any more Transformers. In any case when a new customer comes to us we like to feel

that in 20 years  
time we shall  
still be  
making some  
very good  
Transformers  
for him . . .

PARMEKO OF LEICESTER.  
MAKERS OF TRANSFORMERS.

# LONDON CENTRAL RADIO STORES

**—NEW PURCHASE—  
EX-R.A.F. R1155 COMMUNICATION RECEIVERS**

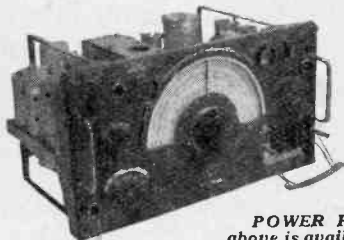

These sets are equal to new, need only a power pack for immediate use (see "W.W.", July, 1946). Freq. range, 7.5 mcs. or 1,500 kcs., complete with 10 valves, including magic eye. Enclosed in strong metal box. Each receiver is **£17.10.0** Carriage and pack by 7/6 extra. No C.O.D.

**POWER PACK 220-250 v. AC for above is available to CALLERS ONLY.**

## BARGAIN OFFER IN P.M. SPEAKERS

5in. Cone, less transformer. New . . . . . **19/6**  
8in. 3-ohm Voice Coil, less transformer. New . . . . . **22/6**  
12in. Goodman's 15-ohm Voice Coil, less transformer. **26/5s.** Od., plus carr. 5/6.

**SLIDING RESISTANCES**  
Braun new, Levey duty, 14 ohms, 5 amps. **13/6**  
12 n.k.z.

**CO-AXIAL CABLE**  
Plastic covered, suitable for Television, etc., 80 ohms. per yard **1/-**

## HEAVY DUTY HORN-TYPE PROJECTION MOVING-COIL LOUDSPEAKER UNITS

Will handle 16-12 watts. Ex-Admiralty type. 15-ohm voice coil. Permanent magnet. New **£3.17.6** condition . . . . .

**PLATINUM CONTACTS**  
Double Spring, mounted on ebonite. **1/6**

**MIDGET CONDENSERS**  
3 gang 0.00050, less trimmers. **10/6**

## Special Purchase TELEPHONE LINE or UNISELECTOR SWITCHES

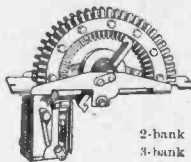

2- or 3-bank, 2t constants. Have various applications: including automatic tuning, circuit selection, etc. Operates on 25/50 v.

2-bank . . . . . **22/6**  
3-bank . . . . . **25/-**

**EX-U.S. ARMY ULTRA LIGHTWEIGHT HEADSETS**  
Deaf-aid type earpieces 7in. dia. with soft rubber ear fittings. 100 ohms. Brand new and packed **27/6**

**EX-GOVT. TELEPHONE HANDSETS. SELF-ENERGISING**  
Set up to battery or current. Less wall bracket. Price per pair handsets. **30/-**

**MOVING COIL INSERTS**

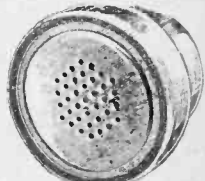

Can be used as Headphones. Midget speakers (with transformer). Speech Mikes or adapted for Pick-ups. All new and perfect. Enclosed in metal case as shown. **5/-** Less case. **3/6**

## EX-R.A.F. AIRBORNE G.P. TRANSMITTERS Type 1154

Complete with 4 valves. Frequency coverage; 500 kc/s, 200 kc/s, 10 mc/s, 3 mc/s, 2.35 mc/s, 8 mc/s, 2.5 mc/s. Power input 1,200 v., 200 in/a. H.T. 0 v 4 amp. L.F. Chassis size, 16in x 13 1/2in x 8 1/2in. In metal cabinet. Supplied in strong wood case, with metal bound corners and carrying handles, easily adapted amateur use. Less **£70.0** Power Pack . . . . .

Without Valves and Meters. **30/-**. Carriage and packing, 7/6 extra. No C.O.D.

## ELECTRO-MAGNETIC COUNTERS

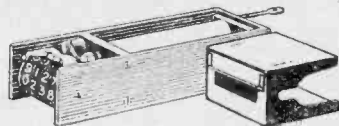

Ex-G.P.O., every one perfect, electro-magnetic, 500 ohm coil, counting to 9,999, operated from 25 v.-50 v. D.C., many industrial and domestic applications. **5/6**

### AN INVITATION

We have a new selection of EX-ARMY, R.A.F. and ADMIRALTY Receivers and Radar Equipment in stock, too numerous to advertise. Pay us a call. It will pay you!

Closed Thursdays 1 p.m. Open all day Saturday.

**23, LISLE ST. (GER 2969) LONDON, W.C.2**

# COMPONENT DESIGN TRENDS

## Tendencies Revealed at the R.C.M.F. Exhibition

AT last year's private exhibition of the Radio Component Manufacturers we saw the first results of the industry's post-war effort to beat its swords into ploughshares. The 1947 show, held in March, marked the culmination of a year of consolidation in the face of heavy handicaps due to shortages of materials.

In last month's *Wireless World* we gave a list of exhibitors and a classified list of products. In the following pages we review the general trend of design.

**Resistors—Fixed.**—The applications for a resistor of one million megohms must surely be few, but it is a distinct achievement that such astronomical values can be attained in a component of reasonable size. Such resistors, described as Pyromatic, are made by Welwyn Electrical Laboratories in three types for operating voltages of 550 to 1,100. This firm has also produced a new range of wire-wound precision resistors on ceramic formers impregnated and coated with a glass fibre compound. Resistance values range from 100 ohms to 10 megohms and an accuracy of 0.5 per cent can be achieved if required. Otherwise the tolerance is one per cent.

There was a new range of high-power carbon resistors shown by Morgan Crucible which are suitable for the termination of rhombic aerials and as artificial aerial loads for high-frequency and V.H.F. transmitters. They have been successfully used in this manner up to 300 Mc/s, though this is not necessarily their limit of effectiveness. Described as Grade 7 resistors, they can be operated at temperatures up to 200° C and single tubular units are available which will safely dissipate as much as 90 watts on continuous load and several kilowatts on short duration surges.

**Resistors—Variable.**—One of the principal developments over

the past few years has been the wider use of hard, heat-resisting enamels as a coating for wire-wound resistors in order to raise the loading, which in effect is another form of miniaturization. Last year saw the introduction of a number of semi-variable resistors of this pattern while this year rheostats and potentiometers have made their appearance.

These have been developed by the British Electrical Resistance Co. from their "T" pattern toroidal-wound power potentiometers by encasing the resistance element in vitreous enamel. All but the actual track over which

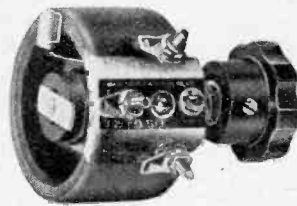

Berco T25E vitreous enamelled 50-watt potentiometer.

the contact arm rides is completely encased in the enamel and this has resulted in doubling the permissible loading of the unit. For example, a T25E (the E denoting enamelled type) will handle 50 watts, but is the same size as the open 25-watt model.

Those firms whose production is largely devoted to items of a specialized nature were showing some interesting devices for control of volume and mixing of signals from various sources, such as would be required at the control centre of a broadcasting organization, or relay service. A novel form of fader was shown by Painton in which the contact arm moves through an arc of about 60° in a vertical plane. The pivot is at the apex of the wedge-shaped frame and when several units are assembled side by side it is possible to operate two controls simultaneously with each hand, a

convenience when immediate muting of several input circuits is needed.

A similar class of component, but designed for high-frequency applications is the Type A38 attenuator made by Advance Components. It is a four-step unit assembled in a massive die-cast case with separate compartments for each resistor and it provides 20 db attenuation per step. There is one spare switch position which could be used for a further stage of attenuation. It has an impedance of 75 ohms and an accuracy of  $\pm 2$  db at 300 Mc/s is attained.

The ubiquitous volume control potentiometer was well represented but there was no evidence of any notable changes in design. Ganged units with a common spindle as well as two-unit assemblies fitted with concentric spindles for independent control were more numerous than hitherto, and many specimens of the latter pattern were shown by Colvern, Reliance Manufacturing, Morgan Crucible and British Electric Resistance.

Miniaturization has also been applied to this type of component, some were seen measuring approximately  $\frac{3}{8}$  in only in diameter in both wire-wound and carbon varieties.

Some very small sliding type variable wire-wound resistors in fully variable and pre-set styles have been developed by Colvern and these should find many applications in miniature equipments,

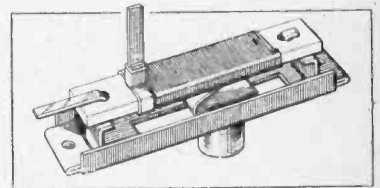

Miniature pre-set resistor made by Colvern.

such as hearing aids and personal portables. They are just under  $\frac{1}{2}$  in long and  $\frac{3}{8}$  in wide and are available in resistance values from 5 to 750 ohms with a rating of  $\frac{1}{2}$  watt.

An inexpensive type of con-

**Component Design Trends—**stant-impedance volume control for extension loudspeakers, was shown by British N.S.F. It consists of seven small resistors assembled on a wafer-pattern switch and is suitable for use with loudspeakers of from 2 to 4 ohms impedance.

**Capacitors — Fixed.** — Whilst few new designs of fixed capacitors have been introduced this year a number of new models have been added to existing ranges to meet current demands, especially in the miniature class. For example, Dubilier Drilitics now include a 25- $\mu$ F, 50-volt model and two have been added to the 500-volt units, one is a 4- $\mu$ F size and the other is of 32  $\mu$ F. There are also additions to the Nitrogol range of special television capacitors in both the rectangular and tubular styles.

As a result of manufacturing changes the T.C.C. range of tiny Picopack electrolytics has been extended and now includes capacitors up to 30  $\mu$ F at 50 volts working. This style is enclosed in an aluminium case measuring  $1\frac{1}{8}$  in long by  $\frac{1}{4}$  in diameter.

Further types of special R.F. by-pass condensers for use on very high frequencies, where even a short connecting lead can intro-

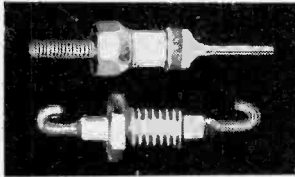

Erie "Stand-off" and "Feed-thru" ceramic capacitors.

duce undesirable inductance, were seen on the Erie stand. Described as "Feed-thru" and "Stand-off" capacitors, according to the style of construction, they have ceramic insulation and one plate of the capacitor is integral with the chassis fixing bush or eyelet, as the case may be. In the "Feed thru" style capacitances from 500 to 1,000 pF are available, while in the "Stand off" pattern the range extends from 150 to 1,000 pF. Further examples of this pattern, although constructional details differ, are included in the products of Dubilier and T.C.C.

**Capacitors — Variable.** — This year the demand for miniature gang-tuning condensers has resulted in some wartime designs being modified for peace-time production. Wingrove and Rogers were showing a two-gang

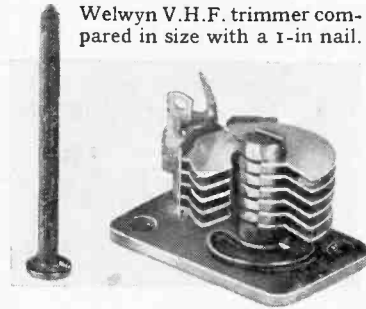

Welwyn V.H.F. trimmer compared in size with a 1-in nail.

model measuring under 2 in long, excluding the spindle, and approximately  $1\frac{1}{2}$  in wide. Capacitance variation is 362 pF, with vane spacing of 0.009 in. There were some further examples of this miniature style in two- and three-gang patterns included in the Plessey range of condensers.

The ordinary variable gang condenser for use in domestic broadcast sets has undergone very little change, except, perhaps, that the number of patterns are now fewer to facilitate production. But most makers can supply quite a wide range of capacitances in the limited designs now available as the same frame is used wherever possible and the spacing between vanes is adjusted to suit the capacitances required.

Miniature air-dielectric trimmers were more in evidence than hitherto and designers of V.H.F. and television equipment have a very wide choice, not only in size and in capacitance, but also in make. They were shown by Wingrove and Rogers, Jackson, Plessey, S. Bird, Stratton, Mullard, Walter Instruments and Welwyn Electrical Laboratories, the last mentioned make being no larger than a finger nail, yet it provided the useful maximum capacitance of 32 pF.

Specialist requirements are still well catered for by S. Bird, who also continue their range of transmitting capacitors in single and split-stator types. Many of these are suitable for high-voltage and high-power operation in industrial radio heating apparatus.

Variable capacitors for the amateur transmitter were included also in the exhibits of Labgear, this firm using Mycalex for insulating the stator sections.

**Plugs and Sockets.**—Flat pin plugs and sockets, similar in general design to the American Jones pattern used extensively in certain wartime radio equipments, are now being made by Painton. These are the small type rated at 5 amps per contact and they are available with from 2 to 33 pins. Contacts are made of beryllium copper with the resilience incorporated in the socket portion, the design being such that neither floating pins nor sockets are required. Complete protection of live parts is afforded when plug and socket are fully engaged and a cable grip is included to relieve individual wires of strain.

The flat pin type of construction is not entirely new to this country as A. F. Bulgin and Co. have been making this variety for a number of years in a limited range for headphone and loud-speaker extension points so as to prevent confusion with electric supply entries.

Several new models have been added to the Belling-Lee range of television and car radio co-axial plugs and sockets. Polythene insulation is used and the capacitance of the assembly is approximately 3 pF. They accommodate cables of from  $\frac{1}{8}$  in to  $\frac{1}{4}$  in diameter over the shield and a design of shield grip is used that obviates the need for soldering.

The styles available include straight-through chassis mounting and cable-extension types as well



Belling-Lee co-axial plugs and sockets.

as right-angled patterns with either single or double entries on the one unit.

**Coils.**—Signal-frequency tuning coils are still produced in two



main types: air-cored and dust-iron cored. The former are usually wound on a bakelized-paper tube and are designed for use with a variable capacitor of 460 pF or so. In the superheterodyne types an intermediate frequency of around 460 kc/s is catered for. The coils are in sizes to give coverage from 150 kc/s to 25 Mc/s.

In one make, the Weyrad, two- and three-band coil assemblies are also listed. These have the windings on a common former and cover the medium and long wavebands, and in the three-band type, 6-15.7 Mc/s as well.

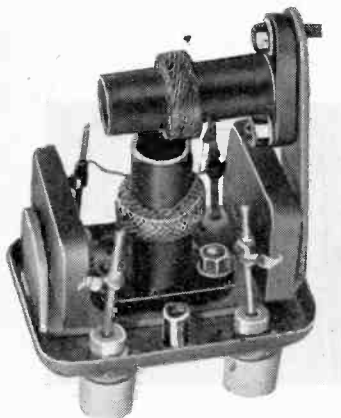

Eddystone 450-kc/s I.F. transformer.

The air-core coils usually have a diameter of the order of  $\frac{3}{8}$  in and are some  $1\frac{1}{2}$ - $2\frac{1}{2}$  in in length. The iron-core types are smaller and tend to be around  $\frac{3}{8}$  in diameter and  $1\frac{1}{4}$  in long. Moreover, they have the great advantage of being adjustable for inductance.

Coil packs, comprising the signal and oscillator coils of a superheterodyne together with waveband switches and trimming capacitors wired ready for connection to the valve and tuning capacitor are made by a number of firms. Wearite have two three-band models providing either medium, long, and short waves, or medium- and two short-wave bands.

I.F. transformers for broadcast receivers are often made for permeability tuning. The physical dimensions of some types are remarkably small; thus, the Wearite M400 measures  $1\frac{3}{16}$  square by  $1\frac{1}{16}$  high and the coils have a Q of 120. Trans-

formers of this size for frequencies of 1.6, 2.1 and 4.86 Mc/s are also available. The Stratton model has the connections made through metallized-ceramic seals, and after adjustment in the set the complete transformer can be sealed by filling the adjustment holes with wax.

**Valveholders.**—A useful panel mounting octal valveholder, very suitable for experimental "bread-board" layouts, was noted on the stand of McMurdo Instrument Co. This firm is now handling valveholders made under "Amphenol" licence.

**Loudspeakers.**—There are welcome signs that loudspeaker makers have found time during the year to break away from the task of meeting the insatiable demand for small broadcast receiver types to produce a few high-quality models, a notable example being the Vitavox "Bitone" consisting of a multi-cellular horn type H.F. unit in conjunction with a low-frequency cone mounted in a vented cabinet.

The Tannoy ULS/15 with 15 in diaphragm is now available with either a copper voice coil for general-purpose work giving uniform response up to 6,000 c/s and above that a drop of 6 db per octave, or with an aluminium voice coil unit giving a response up to 12,000 c/s.

Goodmans have re-introduced a double-cone high-fidel-

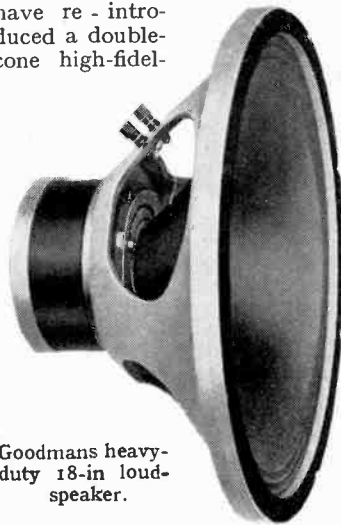

Goodmans heavy-duty 18-in loudspeaker.

ity unit. This is the T2/1206/15 with a power handling capacity of

15 watts. Another notable unit shown by this firm was the T11/1801/6 "extreme heavy duty" permanent magnet loudspeaker with 18 in diaphragm having a power handling capacity of 50 watts.

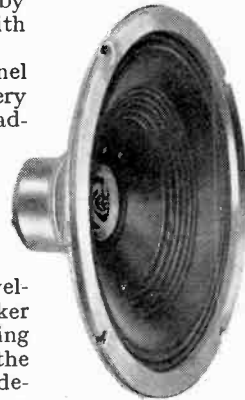

A multi-unit reflexed horn projector by Reslo is rated for a peak output of 90 watts and a sustained rating of 60 watts.

Electro Acoustic Industries loudspeaker for television receivers.

Electro Acoustic Industries are producing, in addition to the high-efficiency 5 in unit for all-dry portables, a new 8 in unit for television receivers. This is fitted with a specially designed magnet system with a very reduced external field—an important point where the loudspeaker must be mounted near the cathode-ray tube and might distort the picture. The outer shell of the magnet forming the return path is of soft magnetic material having a much higher permeability than the centre permanent magnet which it encloses.

The new range of loudspeaker units shown by Teledictor are interesting. They make use of speech-coil windings in which one layer is wound inside and the other outside the cylindrical paper former.

**Cables and Wires.**—A wide variety of R.F. cables, usually with polyethylene dielectric, was shown and they have considerable application in television. There are three main types, coaxial, twin-wire unscreened and twin-wire screened. The impedance is usually about 70 ohms, but coaxial types down to 50 ohms and twin-wire up to 160 ohms are available.

T.C. and M. Co. have a special anti-microphonic coaxial cable in which there is a low-resistance covering adhering to the cable core immediately below the braiding and it is claimed that the noise

### Component Design Trends—

produced by flexing and impact is reduced by as much as 50 db. This firm is also producing a coaxial cable with a double outer metal-braided sheath which is claimed to increase the screening by 6-30 db according to frequency.

Connecting wires, both flexible and non-flexible, are made with P.V.C. insulation in a wide variety of bright colours. The older form of insulation for internal connections—sleeving—is still produced, however. P.V.C. is common here also, but the varnished-fabric sleeveings are well to the fore and made by a large number of firms.

**Aerial Equipment.**—Television aeriels have been tidied up in appearance during the year; the Aerialite type DLB, for instance, is now fitted with an attractive moulded insulating shroud at the centre.

Belling and Lee were showing a new inverted "V" dipole television aerial suitable for suspension from the ridge inside the roof of a house. It is stated that the aerial is inherently directional with a high maximum / minimum ratio and may be used to discriminate against "ghosts." It is suitable only for high field strengths, say up to a range of 5 miles for indoor and 10 miles for outdoor use with the



Aerialite type DLB television aerial.

present power output from Alexandra Palace.

Telescopic aerial rods suitable for fixing to the sills or window frames of flats or houses, where the erection of a conventional aerial presents difficulties, have been introduced by a number of firms. Examples noted were the Antiference "Silmount" and the Aerialite "Aerimax," with adjustable mounting bases.

**Transformers and Chokes.**—The established methods of trans-

former design and production continue to serve the needs of the in-

A.B. Metal Products D.P.D.T. switch.

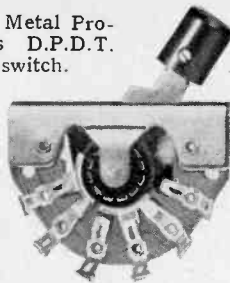

dusty and few innovations were to be found among the products of the firms specializing in these important basic components.

A new range of hermetically-sealed transformers in cylindrical cans with glass seals are made by Parmeko. These transformers have a circuit and essential characteristics printed on the

Partridge twin output transformer unit.

can and present an attractive appearance.

Partridge Transformers were showing a high-quality output transformer with less than 0.5% distortion at 30 c/s at a load of 12 watts; also, a twin transformer output unit providing a cross-over

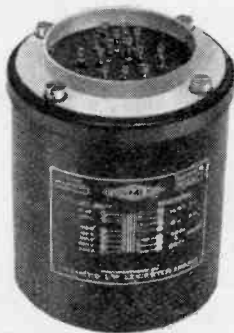

Parmeko hermetically sealed transformer.

network for high- and low-frequency loudspeakers.

**Switches.**—The well-known rotary wafer-type switches are almost universally used for wave-band switching and changes of design are in matters of detail only. The insulant is usually a bakelized-laminated material but small-sized types with ceramic insulation are now made. The principle of this switch has been applied to other modes of operation and lever patterns with the same kind of contact element are now made. A double-pole change-over switch consists of a half-wafer mounted edge-on to the panel with a lever arm, which can be spring-loaded if required.

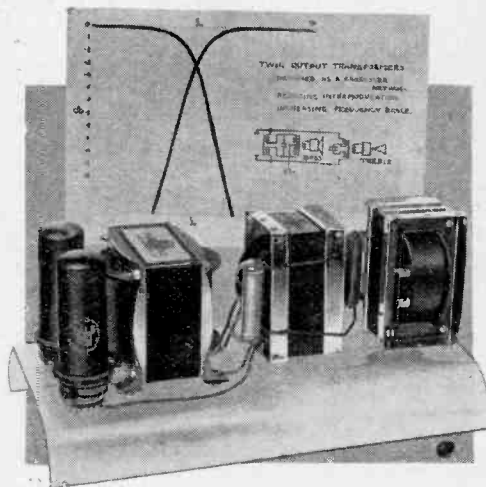

The Oak range of switches has been supplemented by sliding types which are advantageous in economizing space in some layouts. Push-button switches are made with almost an infinite variety of contact arrangements.

For instrument work, such as high-grade attenuators, the well-established rotary steel switches are retained and improvements lie in matters of detail such as the contact materials and the fixing of the contact studs.

**Metal Rectifiers.**—In the Sentercel series of selenium rectifiers made by Standard Telephones is an entirely new range of Uniplate rectifiers for use as half-wave, voltage doublers or bridge-connected units. Four plate sizes are now available (types H5, H6, H7 and H9) and these carry maximum mean forward currents of 1, 2.5, 13 and 40 mA respectively.

Four H6 plates assembled in bridge connection forms a most

compact instrument rectifier for a 0-5 mA meter as it measures only  $\frac{1}{2}$  in  $\times$   $\frac{1}{4}$  in  $\times$   $\frac{1}{8}$  in. This assembly is described as the B6 rectifier. A B9 model containing four Hg plates will pass 75 mA. The maximum reverse voltage these recti-

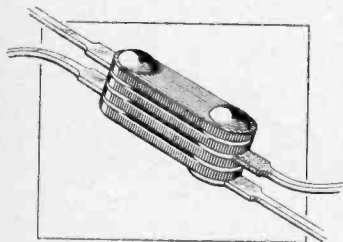

Bridge connected instrument rectifier Type B5 using S.T.C. Sentercel's.

fiers will withstand is 18 volts R.M.S. per unit.

There is also a range of low-current high-voltage Sentercel rectifiers some of which are well suited for use in television receivers, while others should find many applications in cathode-ray oscilloscopes and kindred apparatus. Described as the Types 4 and 10 tubular rectifiers, output voltages up to 2 kV are available from a single unit, the former gives 3 mA output and the latter 10 mA with a capacitative load.

Some new high-voltage low-current models were included in the range of selenium rectifiers made by Westinghouse. One of the latest pattern for C.R.T. and television use is the Type 16H236 measuring about 12 in long and  $\frac{1}{2}$  in diameter. It is a half-wave rectifier giving a D.C. output of 3,730 volts and 8 mA when using a 0.2  $\mu$ F reservoir condenser.

Westinghouse high-voltage rectifier Type 16H236 and low current model Type 16K9.

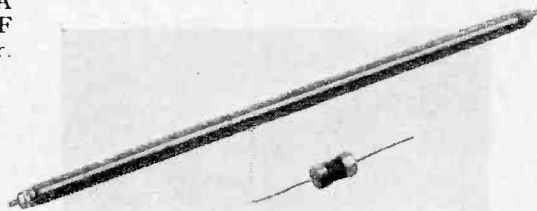

Higher output voltages can be obtained by series connecting several of these units but in general two in series, or as a voltage doubler, will satisfy most television requirements.

A miniature half-wave rectifier which should have a number of applications in small test sets

operated from A.C. supplies is the Westinghouse type 16K9. It measures  $\frac{1}{2}$  in long and  $\frac{1}{2}$  in diameter and gives a D.C. output of 137 volts at 8 mA with a 4  $\mu$ F reservoir condenser.

**Materials.**—Apart from those used in cables and wires, insulating materials in wide use fall into two main categories: ceramic and bakelized - laminated material. The latter is very widely used for switch wafers, valveholders, terminal strips and similar items, while ceramics are more commonly used for insulation in variable capacitors and coil formers. They are, however, also adopted in some cases for valveholders and switches.

Mouldings, while still far from uncommon, appear to be less frequently used for insulation purposes than for what may conveniently be termed external parts. By these are meant such things as control knobs, plug-and-socket covers, and whole cabinets. Here the products are characterized by an extremely clean finish and bright colours.

Metal-ceramic and metal-glass seals are becoming more widely used on apparatus for tropical use, and there is a tendency to adopt multi-lead seals in preference to using a number of single seals. Six-way metal-glass seal units—in appearance very like a ring-seal valve base—are being used for A.F. transformers among other things.

A wide range of flexible insulating sheet material is now available ranging from the well-known varnished fabrics, such as Empire cloth, to polyethylene.

Magnetic core materials for transformers, chokes, and motors were shown by Magnetic and Electrical Alloys, Geo. L. Scott, and T.C. and M. Co.

Mumetal screens in the form of boxes for screening small components and as cathode-ray tube shields were on view.

## Radio-Communication Convention

### List of Main Papers (See p. 158)

- Telecommunications in War, Colonel Sir Stanley Angwin.
- Long-Distance Point-to-Point Communication, A. H. Mumford.
- Low-, Medium- and High-Frequency Communication to and from H.M. Ships, E. J. Grainger and W. P. Anderson.
- Military Radio Communications, Brigadier J. B. Hickman.
- Aeronautical Communications, B. G. Gates.
- Pulse Communication, D. Cooke, A. J. Oxford, Z. Jalonek and E. Fitch.
- Ultra-High-Frequency Technique Applied to Mobile and Fixed Services, J. Thomson, J. D. Denly, I. J. Richmond, F. Pugliese and H. Borg.
- Résumé of V.H.F. Point-to-Point Communication, C. W. Sowton and F. Hollinghurst.
- Naval Radio Direction-Finding, C. Crampton.
- Fundamental Problems in Radio Direction-Finding at High Frequencies (3-30 Mc/s), W. Ross.
- Wartime Activities of the Engineering Division of the B.B.C., H. Bishop.
- The Investigation and Forecasting of Ionospheric Conditions, Sir Edward Appleton.
- The Influence of Propagation on the Planning of Short-Wave Communications, K. W. Tremellen and J. W. Cox.
- Manufacturing Aspect of Component Developments, E. M. Lee.
- Component Development for Wartime Service Applications, I. M. Ross.
- Review of the Convention and Future Trends, Sir Clifford Paterson.
- The Development of C.W. Radio Navigation Aids, with Particular Reference to Long-Range Operation, R. V. Whelpton and P. G. Redgement.
- A Survey of Continuous-Wave Short-Distance Navigation and Landing Aids for Aircraft, Caradoc Williams.

## New Ekco Console

**P**USH button tuning for five stations and provision for reception of television sound are features of the new Model C36 console produced by E. K. Cole, Southend-on-Sea. The 4-valve plus rectifier circuit covers the usual short, medium and long wavebands and includes a 4-position tone control. The output pentode operates with negative feedback and delivers 2 watts. The price is £31 10s plus £6 15s 6d purchase tax.

### Designing an F.M. Receiver

The concluding instalment of this article is unavoidably held over until our next issue. In Fig. 3 of Part 1 it is regretted that coupling condensers between anode and grid circuits were inadvertently omitted; a convenient value for these would be 0.001  $\mu$ F.

# RANDOM RADIATIONS

By "DIALLIST"

## The Way of the Translator

ONE is liable to get a variety of shocks (and not a little amusement at times) from reading a translation into a foreign language of something that one has written. Certainly I got both when I opened at random the French version of a little thing of my own and saw in the very first sentence that my eyes lit upon the remarkable expression "*Si vous chronométrez un programme de télévision . . .*" Can you guess what it was meant to represent? The translator had apparently looked up "watch" in his dictionary and found *chronométré*. Since "watch" was obviously a verb in the text, he gaily coined a French verb as its equivalent! The real gem is his translation of "American cloth," which becomes *toile grossière telle que celles dont sont faits les vêtements américains*. I could forgive him such little fantasies had he stuck to that kind of thing; but it ceases to be funny when a translator renders "repelled" by *attiré*, "it is not correct" by *il est exact* and makes the most frightful mess imaginable of converting yards, feet and inches into metric units. Ah me!

□ □ □

## B.B.C. Recordings

RECENTLY I spent a most interesting afternoon going round the B.B.C.'s recording department. It's a rather remarkable show; the whole of the disc-recording apparatus is of their own design and I should doubt whether there is anything to compare with it anywhere else. They have even their own stylus-making department, where the sapphire tips that are used are ground, polished and shaped with minute accuracy to a carefully worked out design. After seeing and hearing what I did I'm quite satisfied that the B.B.C.'s own disc recordings are about as good as such recordings can be; but I still make these contentions:

(1) No disc recording can ever be quite so good as an original broadcast.

(2) Though recordings must be used for repeat performances in both home and overseas programmes, there is no excuse for employing them in the home broadcasts for such features as "American Commentary."

(3) Far too many of the "pressed" records—discs, that is, bought from manufacturing con-

cerns—in the B.B.C.'s "library" are badly worn, scratched or wobbly. These records are largely used as "fill-ups" between items. The record library is much in need of a thorough overhaul, which would ensure that faulty records were withdrawn from service.

## Fidelity

One of my contentions (that no disc recording can be as good as the original) is borne out by a test which can be made on the B.B.C.'s own apparatus. In one studio there are twin recording instruments which are normally used, so to speak, in series: that is, instrument B comes into action when instrument A has filled its disc. But the existing switching arrangements make it possible to "tap" the record made by either instrument and to use the other to make what we may call a second-hand recording—a recording from the first record. When B has made a "second-hand" record from A, A can make a "third-hand" one from B and so *ad infinitum*. It is found that the second-hand copy is more or less acceptable; many people don't find much wrong even with the next. But when it comes to the fourth-hand or fifth-hand copies there are few who don't disapprove heartily. Something, in fact, is lost at each stage from the first onwards: in other words, there is no such thing as a completely faithful disc recording. One of the worst drawbacks of this kind of recording is scratch. Gramophone addicts apparently get used to it and cease to notice it; but I never do and the worst of it is that the better the response of your wireless set the more annoying is the needle scratch. Unfortunately, it is just random noise and you can't really do much about it by filtering. The only palliative is to cut a whole chunk of high audio frequencies and lose a good deal of "top" in getting rid of a little of the scratch.

## Bound to Come

It was a revelation in the reproduction of recorded sounds to hear at the B.B.C.'s Maida Vale studios the latest model of the German Magnetophon using the latest type of coated plastic tape. This kind of tape is inherently pretty free from noise and the particles of iron in the coating get such a shaking up in the H.F. field through which they pass before reaching the recording head that they are com-

pletely demagnetized and purged of all possible sources of noise before they are called upon to receive the magnetizing impulses due to the sounds that are being recorded. The effect of the H.F. field practically amounts to putting each individual particle through its entire hysteresis curve in a fraction of a micro-wink! This kind of recording and reproduction, when at its best, is better than anything that can be done with disc and needle. In my humble opinion it is bound to supersede them for broadcasting purposes. The coming of F.M. broadcasting, with its high fidelity and its reduced contrast-compression, will undoubtedly intensify the need for better recording methods than those now in use and I believe that the answer to the problem will be found in developments along the lines of the Magnetophon. All that, however, will take some time. Meanwhile, the B.B.C. undoubtedly possesses a live, able and enthusiastic recording department and the records that they make themselves are probably the best of their kind in the world. If they will weed out their worn and damaged "fill-ups" and will use recordings only when they must be used, I think they'll come in for far less adverse criticism.

## MANUFACTURERS' LITERATURE

LEAFLET describing the "Tele-master" inter-departmental communication system, and advance specifications of B.S.R. direct disc recording equipment from Birmingham Sound Reproducers, Claremont Street, Old Hill, Staffs.

Details of "Midgetron" valves for hearing aids, cold cathode three-electrode valve, type ZO, and leaflet describing miniature earpieces from Park Royal Scientific Instruments, 52, Minerva Road, London, N.W.10.

Technical data on "Nilo-K" glass-to-metal sealing alloy from Henry Wiggin and Co., Wiggin Street, Birmingham, 16.

Catalogue of "Voltac" insulating varnishes and compounds, with full details of physical properties, methods of control in use, etc., from the Indestructible Paint Co., 6, Chesterfield Gardens, Curzon Street, London, W.1.

Illustrated leaflets describing "Midget" and "Easidun" electroplating plants from Runbaken Electrical Products, 71-73a, Oxford Road, Manchester, 1.

Leaflet describing the Burgoyne coaxial aerial connector, from M.O.S., 24, New Road, London, E.1.

"Electrons at War," an outline of the technical achievements of the Valve Division of Standard Telephones and Cables, 63, Aldwych, London, W.C.2.

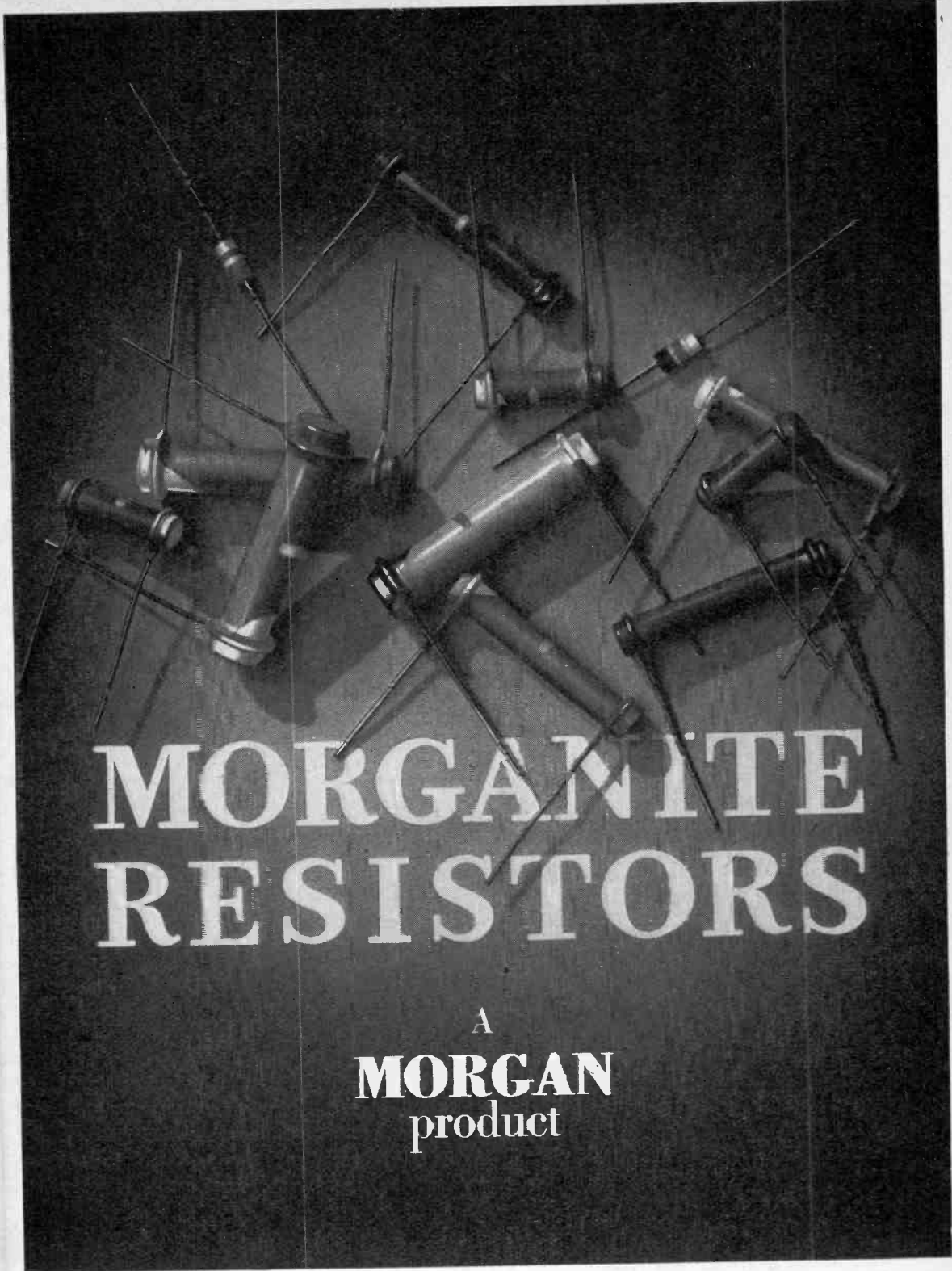

# MORGANITE RESISTORS

A  
**MORGAN**  
product

THE MORGAN CRUCIBLE COMPANY, LIMITED, LONDON, S.W.11

# PERFECT REPRODUCTION

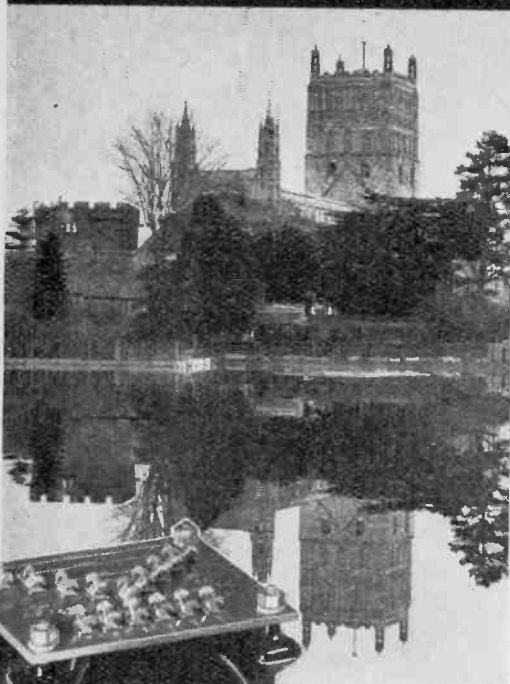

... with  
complete  
dependability

For all installations,  
including PUBLIC  
ADDRESS, either  
indoors or out

# GARDNERS Somerford OUTPUT TRANSFORMERS

COUPON

NAME

ADDRESS

Please send the leaflets marked

- "Somerford" Output Transformer  
 "Somerford" Auto Transformer  
 "Somerford" Mains Transformer  
 "Somerford" Smoothing Chokes  
 "Somerford" Driver Transformer  
 "Somerford" E.H.T. Transformer

GARDNERS RADIO LTD., SOMERFORD, CHRISTCHURCH, HANTS.

FOR RADIO • INDUSTRY • LABORATORY

# PREMIER RADIO

(MORRIS AND CO. (RADIO) LTD.)

ALL POST ORDERS TO: JUBILEE WORKS, 167, LOWER  
CLAPTON ROAD, LONDON, E.5. (Amherst 4723)

CALLERS TO: 169, FLEET STREET, E.C.4. (Central 2833)

LIST AVAILABLE, HUNDREDS OF NEW LINES.

TERMS OF BUSINESS: Cash with order or C.O.D. over £1.  
All enquiries must be accompanied by a 2d. stamp.

## RADIOGRAM CABINETS

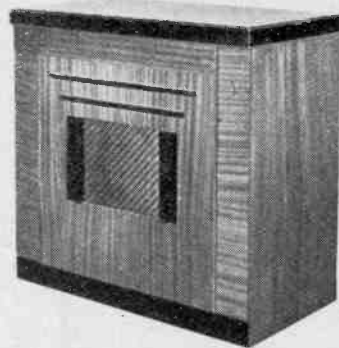

Dignified appearance and good workmanship.  
Size, 34 1/2 in. high, 19 in. deep, 36 in. wide.  
Cabinet only £26, with motor and pick-up,  
£32 16s.

**MIDGET RADIO KIT.** Build your own Midget Radio. A complete set of parts, including valves, loudspeaker and instructions. In fact, everything except cabinet necessary to build 4-valve Medium and Long Wave T.R.F. Radio operating on 200-250 v. Mains, A/C or D/C. Valve line-up, 6K7, 6J7, 25A6, 25Y5. Wave-lengths covered 200-557 and 700-2,000. Size 10 x 6 x 6 in. Completely drilled chassis. Price, including tax, £7 7s. 6d.

An attractive bakelite cabinet can be supplied at 25/- extra or wired and tested in cabinet. Price £10 19s. 6d.

**SUPERHET MIDGET RADIO KIT.** A complete kit of parts for a 5-valve superhet. Covers 16.50 and 200-557 metres. AC/DC 200-250 v. 6K8, 6K7, 6J7, 25A6, 25Y5. Size: 10 x 6 x 6 in. Completely drilled Chassis. Price, including tax, £8 5s.

An attractive bakelite cabinet can be supplied at 25/- extra.

**1947 MODEL COLLARO MICROGRAM.** A super quality 3 1/2-watt amplifier contained in a neat leatherette-covered portable carrying case, with a quality Electric Motor, Pick-up and Loudspeaker incorporated. Just the thing for quality record reproduction. Price, £20 10s. 8d.

**FIVE 5-VALVE SUPERHET RADIO.** Employ CCH35, EF39, EBC33, CL33, CY31 valves; operate on 100-250 volts AC/DC mains. Cover 13-40, 40-100, 200-550 metres. Gram position on wavechange switch. EXT L/S terminals, 8-inch energised Speaker; dial aperture 12 x 4 in.; enamelled steel cabinet, 18 in. high x 15 in. wide x 9 in. deep. Manufactured by Portogram Ltd., for Navy Welfare Centres. A fortunate purchase enables us to offer these fine sets at £15 15s., including Purchase Tax. Packing and carriage 10/- extra. Strongly recommended as a Radiogram Chassis in conjunction with Cabinet, illustrated above.

**COLLARO PORTABLE RECORD PLAYERS.** Consist of a super quality induction type gramophone motor 200-250 v. A/C with autotop and high-grade magnetic pick-up. Mounted in a leatherette carrying case. Price £11 5s. A few only. Delivery from stock.

**MANSBRIDGE TYPE CONDENSERS.** Huge purchase of Military Surplus Paper Condensers. Super quality, oil filled.

Capacity	Working Voltage	Size H	Price Each	Per Doz.
2 mf.	1,000	4 1/2 x 1 1/2 x 1	2/6	20/-
2 mf.	600	3 1/2 x 1 1/2 x 1	1/9	14/-
1 mf.	600	2 1/2 x 1 1/2 x 1	1/-	8/-

**TYPE 103.** Rotary Transformer. Normal rating is 19 v. D/C input. Output 300 volts 30 m/a and 6.5 volts 3 a. D/C. By applying between 200 and 250 volt D/C to the H.T. output side, the two low-tension windings may be used to charge accumulators. The 19-volt side will charge a 6-volt accumulator at 2-3 amps, the 6.5 side a 2-volt accumulator at 1-2 a. with a 12-volt input to the 19-volt side, 180 v. at 30 m/a and 4 v. at 3 a. may be obtained. With a 6-volt input to the 6.5 side, 160 v. at 30 m/a may be obtained. By extending the spindle which is flush with the frame and applying 200 to 250 v. D/C mains to the 300 v. side, the unit becomes a powerful high-speed electric motor, suitable for small drilling machines, etc. Similarly, it may be used with 6 or 12 v. input to the 6.5 v. or 19 v. side. It employs a powerful ring magnet and is of substantial construction costing originally over £5. A fortunate purchase enables us to offer these fine units at 10/-.

All goods advertised in April issue are still available.

# PRE-EMPHASIS AND DE-EMPHASIS

## Why Measured in Microseconds?

By "CATHODE RAY"

THE difference between what is called "high-fidelity" reproduction and the ordinary sort is the upper-frequency limit. If the latter stops at 3000-4000c/s, "high-fidelity" goes up to perhaps 6000 or 8000c/s. Never mind the exact figures; that is the general idea. For various reasons, however, the effort put into achieving "high-fidelity" is not always rewarded with the expected number of phons of acclamation. One of those reasons often is that opening the frequency gate wider to let in the harmonic fairies, that tell us the difference between a violin and a flute, also lets in the noise demons that mess up the whole thing. Since the desired high-frequency sounds seldom represent deep transmitter modulation or full recording, it is generally quite safe to puff them up systematically at the sending or recording end, it being understood that they will be reduced back to normal proportions at the hearing end, in which process the noise (which hadn't the benefit of the extra rations) will be reduced below normal proportions. Pre-emphasis and de-emphasis.

That ought to be clear and understandable enough, but what may be a shade obscure to some readers is the practice of reckoning pre-emphasis and de-emphasis in microseconds (abbreviated  $\mu$ secs). Obviously it is important that all who make receivers for pre-emphasized programmes should know how much they have been pre-emphasized, so as to apply an equal and opposite amount of de-emphasis. The simplest way of enlarging or reducing high frequencies in proportion to low is to use an amplifier coupling whose impedance is constant at the low frequencies and rises or falls at the high. Take inductance in series with resistance (Fig. 1a). At very low frequencies, the inductance does practically nothing. We have, in effect, a

simple resistance coupling, with a level amplitude/frequency characteristic (left-hand end of Fig. 1b). At very high frequencies, the inductance does so much that now it is the resistance that can be neglected. We have an inductance coupling, with a rising characteristic (right-hand end of Fig. 1b). At middle frequencies, where neither resistance nor inductance predominates, there is a gradual transition from level to rising characteristic (middle of Fig. 1b).

The magnitudes of these effects

Fig. 1. (a) Basic pre-emphasis circuit, with its characteristic curve (b).

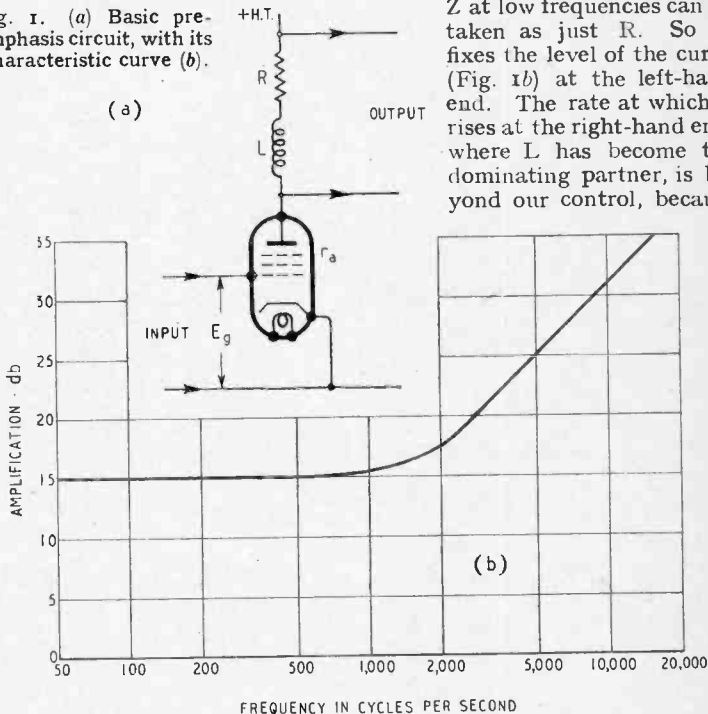

are very much simpler to work out if one can assume that the amount of signal current flowing through the coupling is unaffected by the varying impedance of L, at any rate within the range of frequency concerned. For this to be so, the total impedance of L and R must be small compared with that of

the valve; a condition that is easiest to fulfil by using a pentode or other type with an  $r_a$  of the megohm order. If then the coupling is never more than about 100,000 ohms the signal current can be assumed to be unaffected by it, and therefore equal, as near as makes no matter, to the grid signal voltage (call it  $E_g$ ) multiplied by the mutual conductance of the valve,  $g_m$ . The signal voltage across the coupling is, of course, equal to the impedance, Z, of the coupling, multiplied by the signal current through it. So we have

$$\begin{aligned} \text{Input voltage} &= E_g \\ \text{Output voltage} &= E_g g_m Z \\ \text{And therefore amplification} &= \frac{E_g g_m Z}{E_g} = g_m Z \quad (Z \text{ assumed } \ll r_a) \end{aligned}$$

As we have already agreed, Z at low frequencies can be taken as just R. So R fixes the level of the curve (Fig. 1b) at the left-hand end. The rate at which it rises at the right-hand end, where L has become the dominating partner, is beyond our control, because

if R is neglected,  $Z = X_L$  (the inductive reactance), which is fixed by Nature in the relationship  $X_L = 2\pi fL$ . In other words, the amplification is proportional to the frequency. So the curve rises twofold for every doubling of frequency; that is, 6 decibels per octave. To get a quicker rate it

### Pre-emphasis and De-emphasis—

would be necessary to use more than one stage of pre-emphatic amplification. But 6db per octave is a standard practice.

Obviously the sloping part of the curve can be moved bodily up or down by increasing or reducing  $L$ , which is the only other variable factor. But if  $R$  is simultaneously increased or reduced, the shape of the whole characteristic is not altered in the slightest; it is just higher or lower, which indicates higher or lower amplification of the stage, but is quite beside the point so far as pre-emphasis is concerned. Pre-emphasis is amplification of high frequencies relative to the low, so can be calculated as

$$\text{Pre-emphasis} = \frac{\text{Amplification at any high frequency, } f_h}{\text{Amplification at low frequencies}}$$

$$\approx \frac{g_m \times 2\pi f_h L}{g_m \times R} \approx 2\pi f_h \frac{L}{R}$$

The crucial pre-emphasis factor, then, is not  $L$  or  $R$  separately, but  $\frac{L}{R}$ .

$\frac{L}{R}$ ! That rings a bell somewhere.

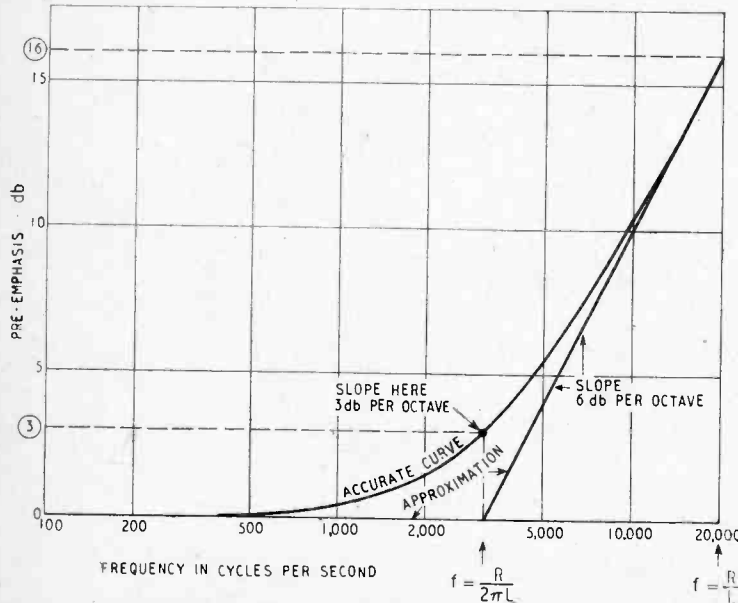

Fig. 2. Characteristic curve for a 50- $\mu$ sec pre-emphasis circuit. It can be quickly sketched by putting in the 16-db point at the frequency equal to  $1/\text{time-constant}$ , drawing a slope of 6db per octave through it, and smoothing it off into the horizontal through the 3-db point, at the frequency roughly equal to  $1/(6 \times \text{time-constant})$ .

Back in basic electrical theory—effect of switching a D.C. supply to a circuit consisting of  $L$  and  $R$

in series. The time the current would take to reach its final value, if it could continue to rise at its initial rate, equals  $\frac{L}{R}$  seconds,

which is called the time constant.

At the present moment we are not particularly interested in what happens when the D.C. supply is connected in Fig. 1a, (but we are interested in any convenient figure that will tell us how much it pre-emphasizes, and at what frequencies. It is clear (I hope) that this already-familiar quantity, the time constant, tells us just that.

For example, in the published results of the B.B.C. frequency-modulation tests, it was men-

tioned<sup>1</sup> that a pre-emphasis of 50  $\mu$ secs was found most satisfactory. That, which may to some have appeared a rather cryptic statement, is now seen to

mean that  $\frac{L}{R}$  in the pre-emphasis circuit was 0.00005, which in turn

$f_h = 8000$  c/s; then the amplification at that frequency, relative to the low frequencies,  $\approx 2\pi \times 8000 \times 0.00005 = 2.5 = 8\text{db}$ .

The approximate sign ( $\approx$ ) in the formula just used above is a reminder that in calculating the amplification at high frequencies we were neglecting  $R$  altogether. That is only allowable well to the right in Fig. 1b, and fails over the important middle stretch. So here, as a matter of interest, is the more accurate and generally applicable formula, subject only to error due to the coupling impedance  $Z$  being assumed negligible compared with  $r_a$ :

Pre-emphasis at frequency  $f_h$

$$= \sqrt{1 + \left(2\pi f_h \frac{L}{R}\right)^2}$$

Fig. 2 shows a characteristic curve for  $\frac{L}{R} = 50 \mu\text{secs}$ , by both approximate and correct methods.

The idea of *time-constant*, although it originally had to do with D.C., is not completely irrelevant to pre-emphasis. It very quickly enables one to sketch the characteristic curve without any formula at all. If the time in "time-constant" is looked on as the time of one cycle of signal, then it gives a frequency, the frequency at which the pre-emphasis is 6.36, or 16db. Try it with 50  $\mu\text{sec}$ . If each cycle lasts for 50  $\mu\text{sec}$ , or 0.00005 sec., the frequency must be 20,000 c/s. So one point on the 50  $\mu\text{sec}$  curve is 20,000 c/s, 16db. An additional point is given by dividing this frequency by 6 (accurately,  $2\pi$ ). That gives the frequency of the middle of the bend, where the pre-emphasis is 2, or 3db. Knowing also that the straight of the slope is 6db per octave, a complete characteristic curve can be sketched in a few moments (Fig. 2).

Remember, however, not to extend the slope so far up that the coupling impedance becomes comparable with the valve impedance, as when that happens the curve starts to flatten out again. This tendency can be postponed by not attempting to amplify much (i.e., by making  $R$  quite small) and by using current negative feedback to increase the apparent  $r_a$  of the valve.

Although few readers will have

tells us the amount of pre-emphasis at any frequency. For example,

<sup>1</sup> *Wireless World*, Oct. 1946, p. 320.



a practical interest in pre-emphasis as such, I have gone through it in some detail, because the same principles apply to de-emphasis, which concerns or is soon likely to concern many, and to tone

the receiver is to see that the time-constant of the de-emphasis circuit is likewise.

The time-constant of a CR circuit is just CR. So after having chosen R to give a suitable

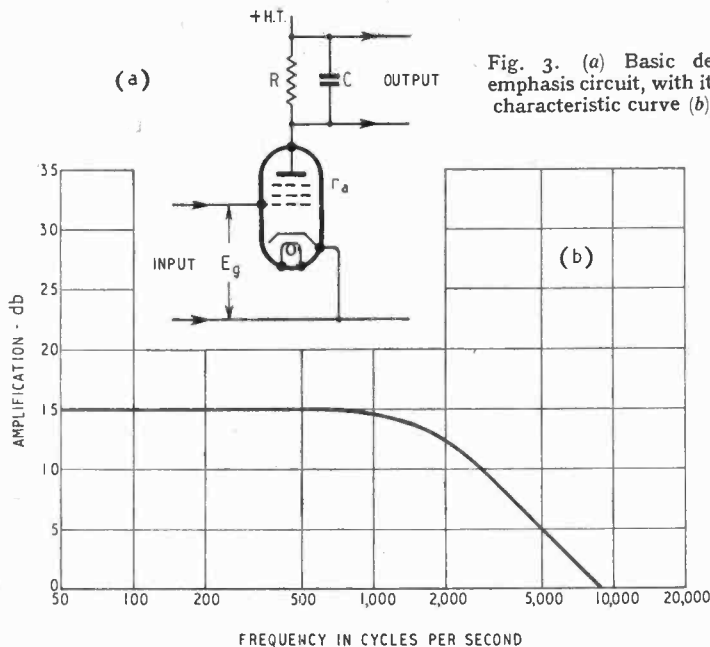

Fig. 3. (a) Basic de-emphasis circuit, with its characteristic curve (b).

control, which concerns almost everybody at some time or other. Also to unintentional distortion due to stray capacitance across the coupling resistor. And even to standard resistors intended for laboratory measurements over a wide range of frequency.

Substituting C for L in Fig. 1a, the reactance rises at the low-frequency end, giving bass lift. Putting L in parallel instead of in series gives bass loss. What we want for de-emphasis, however—high-note loss—is obtained by C in parallel with R (Fig. 3a), and the resulting characteristic (Fig. 3b) exactly straightens out Fig. 1b. At least, it does so if it begins to bend down at the same frequency as the other bends up. For that to happen, the time constant must be the same—another great advantage of the time-constant idea; it obviates calculations. That is just as well, because the fact that the de-emphasis circuit is a parallel one would make it a little more troublesome.

If the standard pre-emphasis is  $50\mu\text{secs}$ , all one has to do at

stage gain, one simply divides  $50 \times 10^6$  (or whatever the pre-emphasis time constant is) by R in ohms to get C in farads. Simpler still, divide microseconds by ohms to get microfarads. A convenient feature is that at the receiving end, where one might grudge a stage doing little but de-emphasizing, there is no reason why R should not be made large enough to give a useful gain; say 50,000 ohms; because that is the maximum coupling impedance. If RC is  $50\mu\text{secs}$  and R is  $50,000\Omega$ , then C is of course  $0.001\mu\text{F}$ . And the de-emphasis curve is just Fig. 2 upside down. To get the curve for any other time-constant, divide the frequency scale readings by the actual time constant relative to  $50\mu\text{sec}$ . For example, for  $75\mu\text{secs}$ , divide all the frequencies by  $1\frac{1}{2}$ .

Pre- and de-emphasis are usually associated with frequency modulation. One reason why it is not much applied to amplitude modulation may be the fear that if by any chance a programme does include strong sounds within the range of boosted frequencies,



**20-WATT UNIVERSAL AMPLIFIER — U885**

Gives considerably greater power output than usually expected from A.C./D.C. equipment. Constructed on the same lines as our 30-watt A.C. model and fitted with latest control panel carrying microphone, gramophone and tone controls, mains switch and pilot lamp and special 3-position switch providing either change-over or mixer circuit for gramophone and microphone. Three-stage high-gain type having four valves in parallel push-pull in output stage, a total of 10 valves.

Full details of this and other models sent on request.

See our Exhibit at the **B.I.F.** Stand No. C.1532 OLYMPIA



**TRIX**  
Quality  
SOUND EQUIPMENT

**THE TRIX ELECTRICAL CO. LTD.**  
1-5 MAPLE PLACE, TOTTENHAM COURT ROAD, LONDON, W.1  
TELEPHONE: MUSEUM 5817 GRAMES & CABLES: TRIXADIO, WESDO, LONDON.

**Pre-emphasis and De-emphasis**—they would over-modulate the transmitter, and the last state would be worse than the first. Also A.M. is thoroughly established on a non-emphasized basis, whereas, F.M. being new, the receivers can be designed to fit pre-emphasized transmissions from the start. Over-modulation with F.M. is not quite so dire at the transmitting end as with A.M.; it means a greater-than-normal frequency deviation. But it is liable to cause distortion at the receiver. It is interesting to note that the B.B.C. recommends 50 μsecs, instead of the American 75 μsecs, on the ground that the advantage in signal-to-noise ratio with the latter was largely neutralized by a necessary reduction in depth of modulation.

A level wide-frequency-range characteristic for gramophone reproduction is unpopular because of the large amount of scratch that it brings in. So pre-emphasis

might seem to be the answer. It certainly has been applied in many American records, but is not invariably a success. It is true that by its use scratch can be almost eliminated without making the record sound like the roll of muffled drums, but the heavy high-note recording is more than most pick-ups can stand without much buzzing and rattling. Moreover it makes acoustic gramophones sound shriller than ever.

The time-constant method is useful when considering how to avoid top-note loss. Suppose 3db loss is judged to be tolerable at 10,000c/s. The corresponding time-constant is the reciprocal of  $2\pi$  times that, say  $\frac{1}{63,000}$ , which is 16 μsecs. So if the unavoidable stray capacitance across the coupling resistor is, for instance, 32pF, the coupling resistance must not exceed  $\frac{16}{32} = 0.5$  megohm.

## SIX-METRE TRANSATLANTIC SIGNALS

### 6,000-km Single-hop Transmission?

By R. NAISMITH

(National Physical Laboratory)

**D**URING the present maximum in solar activity ionospheric conditions should be favourable for long-distance communication on 50 Mc/s. Therefore, there may be an opportunity to consider the efficiency of very long transmission paths when only one reflection in the ionosphere is involved.

The area of reception of the maximum frequency returned by the ionosphere is distinctly limited and is correspondingly difficult to find. It has already been shown<sup>1</sup> that if we use the Appleton-Beynon method<sup>2</sup> for the computation of maximum usable frequencies from measured vertical incidence conditions, accuracies of the order of ±3% can be achieved. We can apply this method to the ionospheric conditions prevailing at Slough on November 24th, 1946, at 16.00 G.M.T. At that time the vertical incidence critical frequency for region F<sub>2</sub> for the ordinary ray was 14.6 Mc/s (only on one previous occasion had this value been ex-

ceeded). The height of maximum ionization at this time was 310 km and the corresponding maximum frequency for transmission by the tangential ray was 48.9 Mc/s over a maximum distance of 5,700 km.

It is interesting, therefore, to read that on the same day H. O'Heffernan<sup>3</sup> was able to receive transmissions from America in Devonshire on 50 Mc/s (of peak strength R8/9) from 16.17-17.20 G.M.T. In Essex D. Heightman<sup>4</sup> received the same transmissions slightly weaker until 17.00 G.M.T. It is significant that the signal appeared at the two stations at approximately the same Universal Time whereas it disappeared at about the same local mean time. The distance involved in both cases was of the order of 6,000 km.

The comparison involves the assumption that the ionospheric conditions over Slough were equally favourable in the reflecting region over the Atlantic. This is a reasonable assumption, since the area concerned would be at approximately the same latitude and would be illuminated by the sun at a slightly earlier local mean time.

The high field strength recorded is also of importance since it indicates a high efficiency of transmission.

There are two other modes of propagation which must be considered. In the first a moderate amount of sporadic ionization in region E at 16.00 G.M.T. may have increased momentarily to permit 50-Mc/s transmission. Alternatively, there may have been an intermediate reflection from the top of region E, making an M-type of path. The sporadic nature of this region E ionization, compared with the long period 16.17-17.20 G.M.T. during which the transmission took place, makes this alternative extremely unlikely.

The second alternative would be by two reflections in region F. Owing to the shorter distances involved the maximum frequency which could be sustained would be 43 Mc/s. Since this is 14% below the observed frequency it is extremely unlikely that propagation was effected in this way.

In conclusion, therefore, it appears that this is the first proved case of highly efficient transmission involving only one reflection over a distance of approximately 6,000 km. It is hoped that there will be many more observations of this type on 50 Mc/s and above from which the accuracy of prediction of maximum usable frequencies may be increased.

#### REFERENCES

- 1 E. V. Appleton and W. J. G. Beynon; "The Application of Ionospheric Data to Radio-Communication Problems — Part I." *Proc. Phys. Soc.*, 1940, 52, 518.
- 2 E. V. Appleton and W. J. G. Beynon; "Some Observations of the Maximum Frequency of Radio Communication over Distances of 1,000 km and 2,500 km." (In course of publication.)
- 3 "Transatlantic 6 Metres." *Wireless World*, 1947, 53, 18.
- 4 E. P. Tilton; "The World Above 50 Mc." *Q.S.T.*, 1947, 31, 50.

#### Ekco Car Radio: A Correction

In referring to the Model CR32 on page 115 of the March issue we mentioned "push-button" control for five medium and one long-wave station. Actually the control is by means of a six-position rotary switch.

# World of Wireless

## INTERNATIONAL TELECOMMUNICATIONS

THE Government has accepted the invitation from the United States government to send delegations to the following international conferences to be held at Atlantic City, to which brief reference was made in our March issue.

An International Radio-communication Conference, to open on May 15th, for the purpose of revising the International Radio-communication Regulations, last revised in 1938, including the allocation of frequencies between the various wireless services.

An International High-Frequency Broadcasting Conference, to be held immediately following the above, to secure a better regulation of long-distance broadcasting services.

A Plenipotentiary Conference of the International Telecommunications Union, opening on July 1st, to draw up a new International Telecommunications Convention to replace that signed at Madrid in 1932, and frame statutes under which the I.T.U. will enter into relations with the United Nations Organization.

The delegation will be led by Sir Stanley Angwin, chairman of Cable & Wireless.

The President and General Secretary of the R.S.G.B are to attend the first conference as representatives of the International Amateur Radio Union.

## MARINE RADIO AIDS

ANOTHER international conference to which a British delegation is being sent is one on radio aids to marine navigation which opens in New York on April 28th. It will be recalled that the first of these international meetings on marine radio aids was held in London last May.

The British delegation, arranged by the Ministry of Transport, will be led by Sir Robert Watson-Watt and includes W. Ross, the Ministry's newly appointed principal scientific officer on radio navigational aids, Lt. R. B. Michell, of the Admiralty Signal Establishment, H. Stanesby (G.P.O.), Grp. Capt. E. Fennessy (Decca), and L. H. J. Phillips (Met-Vick).

## NAVAL WIRELESS RESERVE

THE Admiralty has announced the reconstitution of the Royal Naval Volunteer (Wireless) Reserve, which was originally formed in 1932. At present only officers and men who served in the Navy during the recent war are eligible to join the Reserve which will consist of specialist officers, wireless operators and radio electricians.

Units will be formed in the major towns of Gt. Britain and Northern Ireland. Details of the Reserve can

be obtained from the Admiral Commanding Reserves, Queen Anne's Mansions, London, S.W. 1.

*Wireless World* took a leading part in the formation of the pre-war reserve, known as the Royal Naval Wireless Auxiliary Reserve, for which Vice-Admiral Dorling, now director of R.I.C., was responsible.

## B.B.C. AND F.M.

PLANS for "some thirty F.M. stations to cover the whole of Britain," have been made by the B.B.C. This announcement was made by Sir Noel Ashbridge, during a recent two-way programme between London and New York broadcast from WGY on the occasion of the 25th anniversary of the opening of the station.

He added, "I believe F.M. will be of even greater importance in this country and in Europe generally than it is in the United States since many countries have not been able to develop their programmes as fully as they would like owing to the limited number of wavelengths which have to be shared between a very large number of countries. But at the moment economic difficulties are tending to make progress slower than it might otherwise be."

## PROVINCIAL TELEVISION

CONSIDERABLE confusion has been created in the minds of many laymen by the Assistant Postmaster-General's recent remarks, recorded in our March issue, regarding the definition of the provincial television service.

To counteract the "we'll-wait-for-the-higher-definition" attitude now being adopted by some prospective television set purchasers, the Radio Industry Council has issued a statement from which we take the following extracts.

"Mr. Burke indicated that arrangements had been made to run a two-way link between London and Birmingham so that programmes may be sent in either direction either by cable or radio link. This link, he said, will have such characteristics that it will serve equally for the present 405 line service, and for 1,000 line definition, or colour definition when these are commercially possible.

"Mr. Burke's remarks do not mean, as has been so widely represented, that the Birmingham service is to open on these higher standards; only that the same link will serve when these standards are possible.

"It is not the intention to super-

# BONE CONDUCTION

In the past there was a tendency on the part of Hearing Aid suppliers — particularly outside this country — to make a feature of Bone Conduction.

Now, with improved quality of other means of reproduction and easily worn Miniature earpieces, the use of Bone Conduction is rapidly declining. Nevertheless, there still exists a small proportion of deaf people who hear better by Bone Conduction.

The new Multitone Bone Conductor caters for such cases. It is of high impedance type, having a D.C. resistance of 2,500 ohms. and an inductance of 4 henries with zero D.C.

It will operate with all of our instruments and in fact with any valve instrument having high impedance output and possessing sufficient amplification.

*Multitone Bone Conductor Valve Hearing Aids from 18 guineas*

## MULTITONE

ELECTRIC COMPANY LIMITED  
92, New Cavendish St., London, W.1.

*Signatories to the National Institute for the Deaf Agreement*

## World of Wireless—

sede the present system to-morrow or for many years. Even when improved transmission standards are possible, existing sets will not be rendered obsolete because the programmes will continue to be available on the present standards as well."

### MARCONI JUBILEE

**T**HE jubilee of wireless telegraphy as a practical means of communication is being celebrated this month. We quote from *Electrical Review* of May 21st, 1897.

#### "Marconi Telegraphy"

"The Post Office Telegraph authorities have during the past fortnight been making a series of very interesting experiments with Signor Marconi's system of telegraphy without connecting wires in the Bristol Channel. Experimental stations have been established at Lavernock Point, near Penarth; on the Flat Holmes, an island in mid-channel, and at Breaun Down, a promontory on the Somerset side. We understand that satisfactory signals have been obtained between the first- and last-named points, a distance of, approximately, eight miles. Signals were also exchanged between Lavernock Point and the Flat Holmes. The receiving instrument used was a Morse ink-writer of the Post Office pattern."

### SCIENTIFIC INSTRUMENTS

**A** FEATURE of this year's exhibition of scientific instruments which was held by the Physical Society at the Imperial College, South Kensington, from April 9th-12th, was the number of Government Departments with stands in the enlarged Research Section. There was also an increase in the number of firms exhibiting in the Trade Section, 118 compared with 111 in 1946 and 84 in 1939.

A review of the exhibition will be included in next month's issue of *Wireless World*.

Owing to printing delays the 300-page exhibition catalogue—a valuable work of reference—was not available during the show. Copies will, however, be obtainable from the Hon. Sec. (Business), Physical Society, 1, Lowther Gardens, Prince Consort Road, London, S.W.7, and will cost non-members 6s by post.

### IONOSPHERE RESEARCH

**F**INE particles of meteoric dust in the lower ionized layers of the upper atmosphere are now considered to make a substantial contribution to their reflecting properties at night.

This is one of the conclusions reached by the ionosphere research workers of the D.S.I.R. and expressed by Sir Edward Appleton at a meeting of the Physical Society.

### RADIO INTERFERENCE

**I**N reply to a question asked in the House of Commons on March 19th the Assistant Postmaster-General stated that legislative action to provide for the compulsory suppression of electrical interference with radio reception is being considered.

He also stated that the "valuable recommendations" made by the Council of the I.E.E. would be taken fully into account.

The problem of radio interference has been investigated by the British Electrical and Allied Industries' Research Association (E.R.A.) for some years, especially during the war. A new sectional committee has recently been set up to "study and develop the electrical equipment of automotive systems with particular reference to electrical ignition systems, radio interference suppression devices and electric accessories." The committee, which is in addition to that set up by E.R.A. some years ago to study the question of electrical interference generally, comprises representatives of the Ministries, the motor and electrical industries and the Department of Scientific and Industrial Research.

### COMPACT COMMUNICATION RECEIVER

**D**ESIGNED to withstand rough usage, the Type F.O.509 receiver made by Philips Transmission (Philips Lamps), Century House, Shaftesbury Avenue, London, W.C.2, measures only 12½in by 9in by 8½in, and weighs approximately 21 lb, yet the circuit comprises no fewer than ten valves of the 1.4V type, a neon stabilizer and an internal vibrator for H.T. supply. An R.F. amplifier is followed by a mixer and three stages of I.F. amplification. A beat oscillator

It is claimed that the Philips Type F.O.509 communication receiver will work when completely submerged.

is coupled to the third I.F. amplifier and there are alternative demodulators for A.M. and F.M. reception; a single valve combines the functions of limiter and discriminator. Push-pull output valves

feed a miniature loudspeaker or headphones.

The set is waterproof and practically airtight, but as a precaution a replaceable silica gel desiccator is provided for the interior. Power is provided by a 6-volt battery from which the total drain is 1.65 A. There are four waveranges covering 1 to 20 Mc/s.

### AUCTION SALE PRICES

**C**ONSIDERABLE interest attaches to the prices ruling for surplus radio equipment sold by auction recently from the Ministry of Supply stores on the Watford By-Pass Road.

Most items were sold in large quantities although bidding was mainly on the basis of so much for each item.

Thirty gramophone motors sold for £4 14s each, whilst 5,690 lb of transformer laminations fetched 2s 2d a lb, 200 miscellaneous I.F.F. receivers 12s 6d each, 250 R.A.F. Type R1116 receivers 8s each, 50 heavy-duty hailing-type loudspeakers £3 5s each, 200 3½-in loudspeakers 15s each, 100 galvanometers and 200 voltmeters (0-15, 0-600) 14s each.

Component prices varied at different sales. A batch of 3,000 5 mA instrument rectifiers sold for 1s 2d each, 3,795 miscellaneous electrolytic condensers 1s 6d each, 2,791 assorted high resistance potentiometers sold for £26 (or about 2½d each), 100 intervalve transformers 4s each, 2,000 mains transformers and chokes 1s 9d each, and 3,264 electrolytic condensers 1s 11d each.

Further sales of radio equipment will be held at these stores on May 7th and 21st, and June 4th.

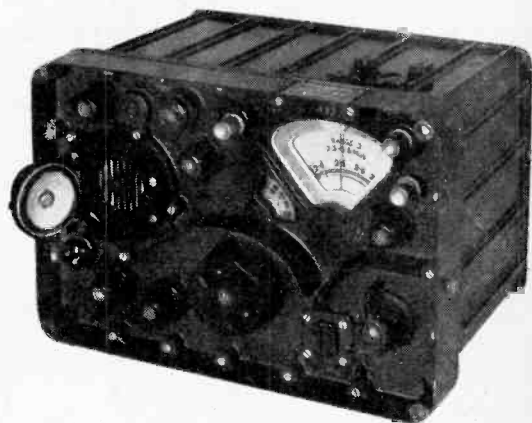

### TELEVISION SOCIETY

**A**T the annual dinner of the Television Society, held in London on April 1st under the presidency of Sir Robert Renwick, glowing tributes were paid to the retiring presi-

dent, Dr. Clarence Tierney, who has guided the Society during the 20 years of its life.

Anticipating the extension of television to the provinces, a Midlands Section, with headquarters at Birmingham, has been formed. There are also two new groups within the Society, one for constructors and another for those interested in the programme side. New members of the Council are A. I. Bray, Vice-Adml. J. W. Dorling (of the R.I.C.) and P. C. Philpot.

#### OLYMPIA, 1947

**P**LANS for the National Radio Exhibition at Olympia (October 1st-11th) are already well advanced. According to present proposals, many branches of radio, besides broadcasting and television, will be covered. A large space will be devoted to electronics, with working demonstrations where possible, while the Services and Government departments will stage exhibits. The convenience of export buyers is being specially studied, while television demonstrations will be arranged so that the performance of various receivers may be readily compared.

#### DANISH BROADCASTING

**A** REPORT in *Wireless World* over a year ago on a tentative proposal to employ very short waves exclusively for Danish internal broadcasting has since been given wider and perhaps rather misleading publicity. We are now asked by the Danish Department of Posts and Telegraphs to say that no arrangement has been made for V.H.F. broadcasting in Denmark. The Kalundborg station will continue to radiate the Danish home programmes, and will not (as was suggested in the proposal) be reserved for overseas transmission.

#### PERSONALITIES

Sir Stanley Angwin has been appointed chairman of the Radio Research Board of the Department of Scientific and Industrial Research in succession to Lt. Col. Sir George Lee.

Sir Frank Smith is retiring from the chairmanship of the Scientific Advisory Council of the Ministry of Supply and is succeeded by Sir John Lennard-Jones, the Ministry's chief scientific officer.

Sir Robert Renwick has been appointed President of the Radio Component Manufacturers' Federation in succession to Sir Percy Greenaway.

Sir Edward Wilshaw, who recently relinquished the chairmanship of Cable and Wireless on the Government's acquisition of the company, has joined the Board of the English Electric Co., which purchased the whole interest of Cable and Wireless in Marconi's last year.

Dr. W. B. Lewis, Ph.D., F.R.S., C.B.E., superintendent of T.R.E., has received the American Medal of Freedom with bronze palm for his work on V.H.F. radiation. He was created a C.B.E. in the 1946 Birthday Honours.

H. Jefferson, M.A., A.M.I.E.E., a frequent contributor to our sister journal *Wireless Engineer*, has left Marconi's and joined the Transmission Department of L. M. Ericsson in Stockholm, Sweden.

G. W. Godfrey, who has been appointed general sales manager of Ekco's radio division, is succeeded as radio sales manager by Bentley Jones.

F. C. Robinson and F. J. Dellar have been appointed managing director and sales director, respectively, of Cossor Radar, Ltd.

T. A. Macauley has been appointed chairman and managing director of A. C. Cossor, Ltd., and L. L. Roberts and J. S. Mitchell, general manager and commercial manager, respectively, of the company's radio and television division. These changes have been made following the resignation of J. H. Williams and J. W. Horton as joint managing directors.

A. J. Philpot, C.B.E., M.A., B.Sc., F.Inst.P., director of the British Scientific Instrument Research Association, has also been appointed director of the Scientific Instrument Manufacturers' Association of Great Britain.

#### OBITUARY

We regret to record the deaths of:—  
Lt. Col. W. G. H. Miles, who was responsible for producing some of the early editions of the Admiralty Handbook of Wireless Telegraphy. Commissioned Second Lieutenant in the Royal Marines in 1904 at the age of 18, he was appointed Fleet W.T. Officer on the Cape Station from 1920-1922 and was Head of the Admiralty W.T. Board from 1934-1937, when he retired from the Service. Col. Miles was recalled in 1939 and throughout the war served in the signals branch of the Admiralty. Since the war he has been on the Telecommunications Directorate of the Ministry of Civil Aviation.

E. L. Odhams, at the age of 67, who was editor of the B.B.C. journal *World Radio* until it ceased publication in 1939.

#### IN BRIEF

**Broadcast Licences.**—A slight increase in the number of broadcast receiving licences in force at the end of February is announced by the G.P.O. The total of 10,732,500—including 11,700 television licences—is 500 more than at the end of January, when there was a marked decrease.

**U.N.O. Transmitter.**—The United Nations Organization is now operating the old League of Nations station at Prangins, Geneva. It started transmitting on April 11th on 9.515 Mc/s.

**Peruvian Show.**—A radio exhibition to last three weeks is to be opened at Lima, Peru, on July 27th.

**B.S.R.A.**—A printed journal is to be published by the British Sound Record-

# A 'SOUND' PROPOSITION!



## ARE YOU A TANNOY STOCKIST?

A restricted number of qualified dealers and P.A. specialists are being appointed as approved stockists for the main trade distribution of Tannoy Sound Equipment.

Having declined to jeopardise the reputation of TANNÖY by the introduction of interim equipment to meet insistent demands for "anything at any price", the extensive post-war range of TANNÖY Sound Equipment which is now becoming available, embodies all the latest technical developments in design and the highest quality of manufacture. The trade mark "TANNÖY" remains a guarantee of reliability to you and your customer.

Write for the qualifications required of stockists and for complete details of the full range of TANNÖY Equipment.

# TANNOY

—SOUND EQUIPMENT—

## GUY R. FOUNTAIN LTD.,

"THE SOUND PEOPLE"

"TANNÖY" is the registered trade mark of equipment manufactured by

GUY R. FOUNTAIN LTD.,  
WEST NORWOOD, S.E.27.  
GIPSY HILL 1131.

The largest Organisation in Great Britain  
specialising SOLELY in Sound Equipment.

Branches throughout the British Isles.

### World of Wireless—

ing Association in place of the duplicated sheets issued hitherto. Arrangements are also being made to publish a number of booklets and pamphlets on recording and allied subjects. A scheme of regional centres is planned, the first of which is the North-East. The representative is H. Dagnall, M.A., 93, Nab Lane, Mirfield, Yorks.

**Brit.I.R.E. Convention.**—A radio convention has been planned by the British Institution of Radio Engineers and will be held at the Tollard Hotel, Bournemouth, from May 19th-23rd.

**Electronics Exhibition.**—The second annual electronics exhibition to be sponsored by the Institution of Electronics will be held in the Great Hall, College of Technology, Manchester, on July 22nd and 23rd, from 2.30-9.0 and 10.0-9.0, respectively. Admission will be by ticket, which is obtainable from A. Coates, 16, Didsbury Park, Manchester, 20.

**Ohm's Law?**—The following extract is taken from an announcement in the *Cambridge Daily News*:—

**WATTS—AMPS.**—The engagement is announced between.  
The reader who kindly sends the cutting adds, "I hope they have a good ohm to go to."

### INDUSTRIAL NEWS

**Scottish Exhibition.**—The Scottish Committee of the Council of Industrial Design is arranging an exhibition of industrial design which will be held in Edinburgh in August and September. The radio industry will be represented at the exhibition, which is to be called "Enterprise Scotland 1947."

**Foire de Paris.**—A feature of this year's Trade Fair, which opens in Paris on May 10th, will be the separate exhibition of radio, television and cinema apparatus in the Grand Palais (Champs Elysees), part of which is being used to supplement the established Fair grounds at the Porte de Versailles.

**B.E.T.R.O.**—Among the enquiries recently received by the British Export Trade Research Organization was one for listening habits in certain markets overseas.

New research laboratories have been opened by Elliott Bros. (London) at Elstree Way, Boreham Wood, Herts. Covering 50,000 sq ft, the new laboratories, under the direction of J. F. Coales, O.B.E., M.A., will be devoted to the development of industrial measuring and control devices.

**British Moulded Plastics, Ltd.**, is the new name adopted by De La Rue Plastics, Ltd., which has been acquired by National Plastics, Ltd., 84-86, Regent Street, London, W.1.

**Change of Address.**—Coulphone Radio, from New Longton, Nr. Preston, to 58, Derby Street, Ormskirk, Lancs.

**Edstone, Ltd.**, sole concessionaires for the Lectrona loudspeaker, has moved to 7, Princes Street, London, S.W.1. Tel.: WHI 0785-6.

**Scophony.**—At the annual general meeting of Scophony, Ltd., the chairman, Sir Maurice Bonham Carter, announced that the company is developing home television receivers with a viewing screen of about 24 inches.

**"How it Changed Our Lives"** is the title of an attractive 44-page brochure issued by E. K. Cole telling the story of the dispersal of the Ekco factories and of the company's return to peace-time production.

**V.S.E. Construction Co.**, of 5-7, Denman Street, London, W.1, will be exhibiting in the radio section of the British Industries Fair which opens on May 5th.

**D.P. Battery Co.** is exhibiting in the electricity section of the British Industries Fair.

**H. A. Hartley Company's** new premises at 152, Hammersmith Road, London, W.6 (telephone: Riverside 7387), are now open for the demonstration of Hartley-Turner equipment.

**Radio-Aid, Ltd.**, has opened retail premises at 29, Market Street, Watford, Herts.

### CLUBS

**Birmingham.**—The electron microscope will be dealt with by Dr. W. Wilson at the meeting of Slade Radio, at Broomfield Road, Slade Road, Erdington, on May 2nd. The meeting on May 16th will be conducted through three points in the area with the aid of 5-metre transmission and reception. Sec.: L. A. Griffiths, 34, Florence Road, Sutton Coldfield.

**Brighton.**—Meetings of the Brighton and Hove Group of the R.S.G.B. are held on alternate Mondays at the "Golden Cross," Western Road, Brighton. The next meeting will be on May 5th, when the subject will be "Mobile and V.H.F. Receivers." Town Representative, Lt. Cdr. J. R. D. Sainsbury, 80, Lansdowne Place, Hove, Sussex.

**Bromley.**—Meetings of the North-West Kent Amateur Radio Society will continue to be held throughout the summer on the last Friday of each month at 8.0 in the Aylesbury Road School, Bromley, Kent. Sec.: L. Gregory, G2AVI, 18, Upper Park Road, Bromley.

**Cambridge.**—R. M. Cooper, of Cooper Manufacturing Co., will address the Cambridge University Wireless Society on the Lexington pick-up and sound equipment on April 28th. Sec.: K. E. Machin, Queen's College, Cambridge.

**Kentish Town.**—St. Pancras Radio Society is participating in an exhibition at the Kentish Town Men's Institute, where they have their headquarters, on June 28th. It is proposed to show an amateur station being operated. Sec.: H. Brown, 84, Blenheim Gardens, Willesden Green, London N.W.2.

**Wigan.**—The Wigan and District Amateur Radio Club has been granted the call sign G3BPK for its transmitter which is operating in the

10-, 20- and 40-metre bands. Sec.: H. King, 2, Derby Street, Spring View, Wigan.

### MEETINGS

#### Institution of Electrical Engineers

**Radio Section.**—"Accurate Measurement of the Group Velocity of Radio Waves in the Atmosphere, using Radar Technique," by R. A. Smith, M.A., Ph.D., E. Franklin, B.Sc., Ph.D., and F. B. Whiting, B.Sc., on May 7th.

Discussion on "Future Trend of Component Design for the Services," opens G. W. Sutton, Ph.D., B.Sc., and E. M. Lee, B.Sc., on May 13th.

Both meetings will be held at Savoy Place, London, W.C.2, at 5.30.

**Cambridge Radio Group.**—"Crystal Valves," by B. Bleaney, M.A., D.Phil., J. W. Ryde and T. H. Kinman, M.B.E., on May 13th, at 6.30, at the Cavendish Laboratory.

**Northern Ireland Centre.**—Lecture on radiolocation by E. C. S. Megaw, M.B.E., D.Sc., on May 20th, at 6.45, at Queen's University, Belfast.

**South Midland Centre.**—"New Possibilities in Speech Transmission," by D. Gabor, Dr. Ing, on April 29th, at 4. "Industrial Applications of Electronic Techniques," by H. A. Thomas, D.Sc., on May 5th, at 6.

Both meetings will be held at the James Watt Memorial Institute, Great Charles St., Birmingham.

**South Centre.**—"The Development and Study of a Practical Spaced-loop Direction Finder for High Frequencies," by W. Ross, M.A., on May 21st, at 7, at the Admiralty Signal Establishment, Haslemere.

**London Students' Section.**—"The Presentation of Technical Information," by A. Duxbury, on May 5th, at 7, at the I.E.E., Savoy Place, W.C.2.

#### Institution of Electronics

**North-West Branch.**—"Radar Navigation," by A. Levin, on May 16th, at 6.45, at the Reynolds Hall, College of Technology, Manchester. Non-members may obtain tickets from L. F. Berry, 105, Birch Avenue, Chadderton, Lancs.

#### Radio Society of Great Britain

"Techniques for the Practical Application of Ionospheric Data to S.W. Transmission and Reception," by T. W. Bennington, on May 30th, at 6.30, at the I.E.E., Savoy Place, London, W.C.2.

#### Television Society

"Television Picture Quality," by C. L. Hirschman, on May 9th, at 6, at the I.E.E., Savoy Place, London, W.C.2.

#### British Institution of Radio Engineers

**North-Western Section.**—Discussion on "Single Side-Band Communication Channels," opener E. C. Cherry, M.Sc., on May 7th at 6.45 at the College of Technology, Sackville Street, Manchester, 1.

#### British Kinematograph Society

"Sound Reproducing Equipment," by H. J. Odell and A. T. Sinclair, on May 18th, at 11 a.m., at the Gaumont-British Theatre, Film House, Wardour Street, London, W.1.

## LETTERS TO THE EDITOR

### Technical Education ♦ B.B.C. Quality ♦ "Pro Bono Publico"

#### Degrees for ex-Servicemen

THERE are many competent engineers who have been unable to obtain degrees, largely as a result of the war. Their future career would benefit greatly if they were able to obtain a degree.

The majority of these engineers, whose age in general lies between, say, 25 and 30, have gained sufficient knowledge and experience to enable them to pass Inter. with very little difficulty, but there is at the moment, so far as I have been able to ascertain, no course of study which is convenient for a large number of them, partly because industry is now spread throughout the country to a very much greater extent than before the war, while educational facilities are still limited to large centres of population. This, together with the fact that a five-day week is now fairly general, makes it more difficult than ever to obtain the necessary extra time for travelling considerable distances in order to go to evening classes or to obtain a full day off every week.

It is suggested, therefore, that it might be practicable to arrange courses of study at a number of technical colleges throughout the country, either in the form of a full day on Saturday or a half day on Saturday and, say, one, or at most two, evenings per week. It should be borne in mind that engineers and physicists of the grade referred to often require to visit their professional institutes for lectures and, therefore, at least one extra evening per fortnight is likely to be occupied.

If those engineers or physicists who are interested in such a proposal would care to communicate with the writer, he will, if the numbers prove to be sufficient, undertake to communicate with the Ministry of Education on this subject in order to ascertain whether something can be done to meet their wishes. Will they please state name, address, whether it is desired to take a degree in physics or in engineering, state the name of the nearest technical college at which it is desired to attend and whether all-day Saturday or part of Saturday and evening work is preferred. To enable such courses to commence in September of this year immediate action is required and, therefore, an early reply would be appreciated.

The following two types of course are proposed and the replies should state which is preferred:

(1) A two-year course, leading to final B.Sc. or B.Sc. (Eng.) for engineers who have already passed Inter. or who will be able to pass Inter.

(2) A similar course, starting in September and lasting, say, three years, for those who would be able to pass Inter. next year.

It should be stressed that the Ministry of Education, to whom a copy of this letter is being sent, cannot be expected to provide such courses unless a genuine need for them exists. O. S. PUCKLE.

R. F. Equipment, Ltd.,  
Langley Park,  
Nr. Slough, Bucks.

#### Shortland Circuit Symbols

(*Wireless World*, March.) *Points from Readers' Letters.*

A PENTAGON, heptagon or octagon is more easily drawn than a circle? What nonsense! Try it. How any of the author's mazy-eyed students could have visualized any electronic action in any of his Epstein symbols is amazing. V. E. WALKER.

Gravesend.

WHILE admitting that the proposed symbols save a great deal of time in drawing circuit diagrams, it is doubtful if this advantage warrants a change. The recognized standard symbols are (with slight variations) used almost universally in every country and it would require international conferences to have them changed.

Carlisle. J. E. PERRIN.

#### B.B.C. Transmissions

THE Chief Engineer of the B.B.C. gives us no hope in his letter published in your March issue, of improvement except in canned programmes. I fail to see why the responsibility of reporting bad transmissions should rest on the listener. Is it too much to expect the B.B.C. to make sure the stuff is all right before it is sent out?

Mr. Bishop's letter shows he has no case. My letter pointed out that occasionally the B.B.C. transmission quality was superb, but the widespread complaint is that the general standard of quality is deplorable. This has no relation to wavelengths and congested ethers

# Vortexion



### C.P.20A 15 WATT AMPLIFIER

For 12 volt battery and A.C. Mains operation. This improved version has switch change-over from A.C. to D.C. and "stand by" positions and only consumes 5½ amperes from 12 volt battery. Fitted mu-metal shielded microphone transformer for 15 ohm microphone, and provision for crystal or moving iron pick-up with tone control for bass and top and outputs for 7.5 and 15 ohms. Complete in steel case with valves.

As illustrated. Price £28 0 0

### "SUPER FIFTY WATT" AMPLIFIER

This Amplifier has a response of 30 cps. to 25,000 cps., within ½ db, under 2 per cent. distortion at 40 watts and 1 per cent. at 15 watts, including noise and distortion of pre-amplifier and microphone transformer. Electronic mixing for microphone and gramophone of either high or low impedance with top and bass controls. Output for 15/250 ohms with generous voice coil feedback to minimise speaker distortion. New style easy access steel case gives recessed controls, making transport safe and easy. Exceedingly well ventilated for long life. Amplifier complete in steel case, with built-in 15 ohm mu-metal shielded microphone transformer, tropical finish.

Price 36½ Gns.

### AD/47 10-VALVE TRIODE CATHODE FOLLOWER AMPLIFIER

For this recording and play-back Amplifier we claim an overall distortion of only 0.01% as measured on a distortion factor meter at middle frequencies for a 10-watt output. The output transformer can be switched from 15 ohms to 2,000 ohms, for recording purposes, the measured damping factor being 40 times in each case. Full details upon request.

Dealers and Export Agents should write for special terms to:—

### VORTEXION LTD.

257-261, THE BROADWAY,  
WIMBLEDON, LONDON, S.W.19

Telephones: Liberty 2814 and 6242/3.  
Telegrams: "VORTEXION, WIMBLE, LONDON."

### Letters to the Editor—

for (as I am advised) the programmes are distorted before they get to the transmitter. I have been told by scores of people that a station like Hilversum sounds far better than the local B.B.C. transmitter. Why?

It is necessary to point out that the radio industry generally is interested in producing better sets. But with B.B.C. transmissions as they are, the urge to do so is destroyed. It is not without significance that the more expensive reproducers catering for discriminating users do not even include a radio receiver.

My numerous correspondents on this matter complain bitterly that doubled licence fees for a service greatly inferior to that of pre-war days is an imposition, and one that is not mitigated by complacency on the part of the B.B.C.

H. A. HARTLEY.

London, W.6.

### Educating the Public

IN the leading article of your February issue you rightly emphasize the fact that the broadcast receiver is a scientific instrument. You also refer to a change in public attitude, "due partly to a general tendency towards mechanization and electrification."

I write to express the hope that the first tendency in this change of attitude will be an awareness of the limitations of these scientific instruments—even the best of them—when used without an efficient aerial system.

Can it be denied that the bulk of the ten million-odd broadcast licensees know next to nothing, and care less, apparently, about the unique possibilities afforded by the

modern receiver; they have been encouraged for so long to use, or rather misuse, them *sans* aerials, *sans* earth, *sans* tears, solely for local reception, or, at best, with some miserable apology for an aerial.

The result of this general practice—the static setting of most tuning dials, or the occasional excursion, through a medley of hisses and crackles, to the "other" station—is too well known to need expansion.

I would also comment on "Diallist's" diatribe against the radio industry for its "lack of vision," at a time when its material and labour resources must be stretched to the limit in establishing and maintaining our new export markets—and sustaining other industries with electronic aids, etc. With less sectional bias, "Diallist" might have expressed amazement at the industry's ability to spare material and labour for even the 4+1 set.

Any "lack of vision," I venture to suggest, is in not preparing for the day, when we can better afford the home consumption of these luxuries: by providing a materially cheaper standard receiver *only* and, equally important, its equivalent in kit form, for home assembly, so that the thousands of mechanically and electrically minded young men and women can help to equip their new homes with receivers of a type more in keeping with the times.

Thus we might reasonably look forward to the day when, having paid for all those shiploads of peaches and pomegranates, as well as the other more homely items needed to sustain us, there will be a *real* and intelligent demand for bigger and better radios for broadcasting and a better appreciation of it.

T. H. KINMAN.

Rugby.

## AMERICAN COLOUR TELEVISION

THE Federal Communications Commission recently heard technical evidence for and against the petition put forward by the Columbia Broadcasting System for authority to operate colour television stations. The petition requested frequency allocations in the 480-920 Mc/s band and the amendment of the F.C.C. Standards of Good Engineering Practice Concerning Television Broadcast Stations to permit the operation of stations utilizing the colour-television system developed by Columbia.

The petition was refused and the Commission's report (Docket No. 7896) dated March 18th, 1947, gives a summary of the evidence and the reasons for the refusal.

In the Columbia system each colour-television transmission occupies a total bandwidth of 16 Mc/s. In the scanning process each picture is scanned in sequence through separate colour filters—red, green and blue. At the receiving end the picture on the cathode-ray tube is viewed through similar filters mounted in a wheel which rotates in front of the tube in synchronism with the transmitter. The transmissions in the separate colours follow each other at the rate of 48 per second, and there are twenty-four complete frames a second. An interlaced scanning system is used.

At the hearing Columbia put forward evidence in support of their system and demonstrated it. Other firms working on colour television opposed the petition and demonstrated alternative systems, but no other firm applied for its system to be approved.

The Columbia equipment demonstrated had a 7-in directly viewed tube and gave a brightness of 15 foot-lamberts on highlights. It was stated that laboratory models produced 22 foot-lamberts. Philco demonstrated a projection set giving black-and-white pictures with a brightness of 35 foot-lamberts.

Columbia took the view that these differences were not important because 15 foot-lamberts was adequate, contrast being more important than intrinsic brightness. In this connection they stated that, under conditions of ambient lighting, the use of the colour filters gave a marked advantage over the direct viewing of the tube face in black-and-white systems. The losses of the filters are operative twice on ambient lighting, since it passes the filter, is reflected from the tube face and passes out through the filter again, but only once for the picture

### Books issued in conjunction with "Wireless World"

	Net Price	Postage
TELEVISION RECEIVING EQUIPMENT, by W. T. Cocking, M.I.E.E., 2nd Edition ... ..	12/6	(5d.)
FOUNDATIONS OF WIRELESS. Fourth revised Edition, by M. G. Scroggie, B.Sc., M.I.E.E. ... ..	7/6	(4d.)
RADIO LABORATORY HANDBOOK, by M. G. Scroggie, B.Sc., M.I.E.E., 3rd Edition ... ..	12/6	(4d.)
WIRELESS SERVICING MANUAL, by W. T. Cocking, M.I.E.E., Seventh Edition ... ..	10/6	(4d.)
HANDBOOK OF TECHNICAL INSTRUCTION FOR WIRELESS TELEGRAPHISTS, by H. M. Dowsett, M.I.E.E., F.Inst.P., and L. E. Q. Walker, A.R.C.S., Eighth Edition ... ..	30/-	(8d.)
BASIC MATHEMATICS FOR RADIO STUDENTS, by F. M. Colebrook, B.Sc., D.I.C., A.C.G.I. ... ..	10/6	(4d.)
RADIO DATA CHARTS. Fourth Edition, Revised by J. McG. Sowerby, B.A., Grad. I.E.E. ... ..	7/6	(4d.)
LEARNING MORSE. 335th thousand ... ..	6d.	(1½d.)
RADIO WAVES AND THE IONOSPHERE, by T. W. Bennington ... ..	6/-	(3d.)

Obtainable from booksellers everywhere or direct (cash with order) from the publishers

ILIFFE & SONS LTD., Dorset House, Stamford Street, London, S.E.1.



itself. The filters used pass only 10 per cent of the light from the tube and so pass only 1 per cent of the ambient light.

Flicker is greatly tied up with this question of picture brightness. The Columbia witnesses disagreed with those of other companies about the point at which flicker becomes noticeable. They stated that it appeared at an illumination of 23 foot-lamberts and became objectionable at 52 foot-lamberts.

The system has been criticized on the score of inadequate brightness. If this is true, then with a brighter picture flicker is likely to become more important. It is affected in some degree by the choice of colour filters, but more generally its reduction involves an increase of frame frequency and so of bandwidth. Columbia were opposed to an increase of frame frequency. The use of tubes with a slow-decay phosphor was suggested by Columbia, but DuMont said that they had found them objectionable and R.C.A. experiments with them had shown them to be very complicated.

The main objection to the use of a higher frame frequency is the increase of bandwidth, which is already 16 Mc/s. In this connection R.C.A. demonstrated a system having a frame rate of 30 per second, instead of the Columbia 24, which could be accommodated within a 12.5-Mc/s band. This employs simultaneous, instead of sequential, colour transmission.

Most of the conflict of evidence was on matters which could readily be settled by trials. The F.C.C. felt that the demonstrations given to them were inconclusive and that extended field trials under domestic conditions are essential. So far it appeared that no more than fifteen receivers had been in operation and that all of them were in the hands of Columbia. In the case of black-and-white pictures, before the present standards were adopted there were at least seven transmitters in operation and several thousand receivers, many of which were in the hands of the public. The F.C.C. did not take the view that large numbers of receivers were necessary for adequate trials, but that a small number would provide the necessary information if tried out under sufficiently diverse conditions.

In refusing Columbia's petition, the F.C.C. pointed out that in their view there were two specific problems requiring careful examination. First, the development of low-cost television receivers. Secondly, experiment with a view to finding methods of transmitting colour television within narrower bandwidths than at present possible.

## a new foot-operated switch

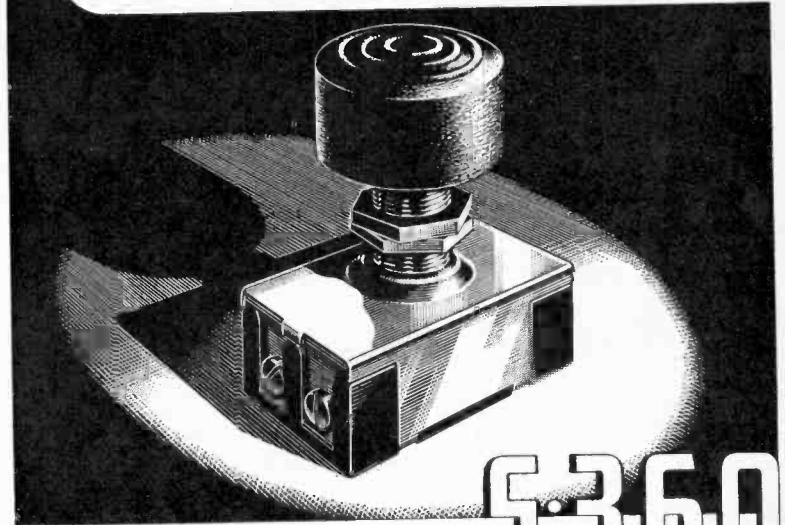

Type **S360**

**E**SPECIALLY designed for appliances which are most effectively and conveniently controlled by a foot-operated switch this new Bulgin Type S360 combines a high efficiency action with absolute reliability. Ideally suitable for vacuum cleaners, hair-dryers, foot-operated drills and other similar apparatus its application covers a wide range of commercial requirements. The S360 is a Push/Push, Single Pole switch and fixes by a single  $\frac{3}{8}$ "  $\varnothing$  hole to panels up to  $\frac{1}{4}$ " thick. It is fitted with a large black rubber knob held captive but easily removable for mounting, and operated by  $\frac{1}{4}$ " displacement at 4½ lbs. min., 6½ lbs. max. pressure. Rear of panel space is approximately  $1\frac{1}{2}$ " x 1" x  $\frac{1}{8}$ " min. rear projection. End terminals are included for connections. Rating:—Working, 250 volt max., 2 A. max. for loads of 1—0.7 p.f. Tested at 1 KV. to E.

**Available for Prompt Delivery**

*"The Choice of Critics"*

# BULGIN

A. F. BULGIN & CO. LTD. · BYE-PASS-RD. · BARKING

Telephone: RIPpleway 3474 (5 lines)

# RECENT INVENTIONS

## A Selection of the More Interesting Radio Developments

### S.W. AERIALS

A WIDE-BAND aerial, particularly suitable for aircraft, consists of a conical element C surmounted by a disc element D, the two poles being coupled

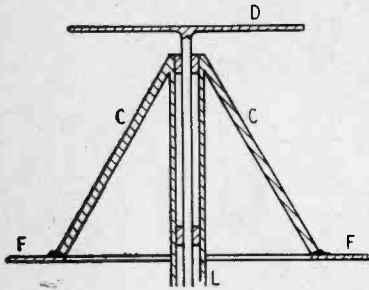

Wide-band aircraft aerial

to the outer and inner conductors, respectively, of a coaxial feed line L. The base of the cone C is welded to the fuselage F. If the latter is of metal it acts as an extension of the lower aerial; if it is of insulating material, it may be coated with a conductive layer over an area determined by the operating frequency band.

The cone may be made shorter in height and wider at the base, and the disc curved over it, so as to make a squat assembly that readily fits inside a streamlined "blister" or casing.

*Standard Telephones and Cables, Ltd.* (assignees of A. G. Kandorian) Convention date (U.S.A.) May 15th, 1943. No. 578457.

### CATHODE-RAY SCANNING CIRCUITS

SAW-TOOTH oscillations are usually fed to the frame deflecting coils of a television receiver, either through a transformer coupling, or else through a choke and blocking condenser, to block out the D.C. component which would otherwise tend to displace the normal focusing of the scanning beam at the centre of the screen.

To avoid the necessity of using a heavy transformer or choke, the H.T. supply for the saw-tooth oscillation-generator is taken, through a series resistance, from the cathode of an auxiliary pentode valve, both valves being biased to operate as Class A amplifiers. At each upward swing of the scanning voltage, a negative

voltage is applied from the series resistance to the grid of the auxiliary pentode. This automatically limits the current supply to an extent that cuts out any D.C. component from the pulses fed to the deflecting coils.

*Marconi's Wireless Telegraph Co., Ltd.* (assignees of T. T. Eaton). Convention date (U.S.A.) September 25th, 1941. No. 577216.

### ELECTRON DISCHARGE TUBE

AN electron beam is first bunched, or velocity-modulated, and is then multiplied, in the same tube, by secondary emission. The high gain thus secured allows both the primary beam, and its transit time, to be kept comparatively small, and so gives the tube a high input impedance.

In the amplifier shown, electrons from the gun G pass through the centre gap in a resonator R, which is coupled to an input loop L. The bunched stream is next projected against a series of secondary-emission electrodes, as indicated by the arrows; the stream is multiplied or intensified at each im-

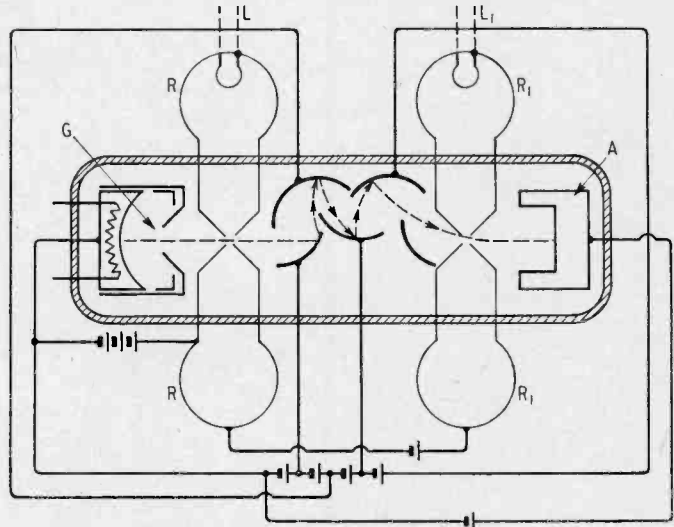

Velocity-modulated electron multiplier

pact, without losing its characteristic grouping, since the new electrons are liberated instantaneously. The augmented stream is then focused through the gap in a second resonator R<sub>1</sub>, where it delivers up energy to be drawn off through the output loop L<sub>1</sub>. The spent electrons are collected from the stream by an anode A.

*Standard Telephones and Cables, Ltd.* (assignees of R. V. L. Hartley and C. V. Parker). Application date April 30th, 1942. No. 578271.

### TELEVISION

WHEN scanning the mosaic screen of a television camera, secondary electrons are emitted and subsequently fall back on to the screen, where they create spurious currents which give rise to the fault known as "shading" in the received picture.

To avoid this effect, the scanning beam is periodically interrupted at a frequency which is higher than any of the signals to be transmitted. During the time when the beam is actually in contact with the sensitive screen, both video-frequency signals and undesired "shading" components are generated. In the intervals when the beam is suppressed, only the shading currents are present. The two groups of signals are opposed in the output circuit of the tube, where the undesired currents counterbalance each other, and leave the radiated signal free from the fault in question.

*Hazeltine Corp.* (assignees of A. V. Loughren). Convention date March 30th, 1943. No. 579600.

### FLUORESCENT SCREENS

THE screen of a cathode-ray tube is given two different coatings of fluorescent material. The first layer, say of zinc-cadmium sulphide, produces a persistent yellowish afterglow. A superposed layer, say of zinc sulphide, reacts to the scanning stream by giving a transient blue flash, which serves to excite afterglow in the layer beneath.

The British abstracts published here are prepared with the permission of the Controller of H.M. Stationery Office, from specifications obtainable at the Patent Office, 25, Southampton Buildings, London, W.C.2, price 1/- each.

The combination is particularly useful for minimizing the effect of casual interference when recording pulses or other cyclically repeated signals, since the afterglow which is gradually built up by such signals is easily distinguished. By viewing the screen through a colour filter that absorbs more blue light than yellow, the originally faint traces of interference are still further diminished.

*A. C. Cossor, Ltd.; F. M. Walker; and E. E. Shelton.* Application date July 13th, 1939. No. 578582.

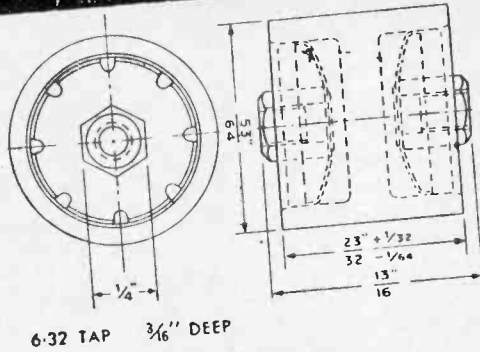

# ERIE DOUBLE - CUP CERAMICONS

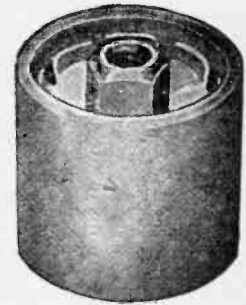

The ERIE Double-Cup Ceramicon, the first of a range of new products scheduled for production in 1947, is the result of the need for a high voltage ceramic condenser that will carry appreciable current at high voltage and will retain the advantage of being a compact, single-piece unit.

As the cross sectional drawing shows, the ceramic dielectric has a centre web which is integral with the tubular casing, providing the required long creepage path. The silver plates are fired on to the ceramic on each side of the web and carried without interruption to the rim of each cup, thus greatly increasing the voltage at which corona occurs. Electrical connections are made by means of electro-silver plated metal terminals soldered to the electrodes.

This design has the necessary basic features for high voltage applications at high frequencies. The web section is sufficiently thick to prevent breakdown of the dielectric, and the design described provides adequate protection against flash-over at the rated voltage. Heavy metal terminals serve to dissipate internal heat and provide a 360° contact for the current to fan out to the electrodes. Rating is 5 KVA.

The ceramic dielectric employed is made of the same titanium dioxide series as the well-known temperature compensating tubular Ceramicons. This material plus careful control of processing operations assures stability with respect to temperature, excellent retrace, and high Q factor.

## RANGE AND CHARACTERISTICS

TYPE 741A		
Standard Capacities	Temperature Coefficient	Peak Wkg. Volts DC at Sea Level
20 MMF	P100	10,000
30 MMF	P100	6,500
39 MMF	P100	5,000
61 MMF	N750	10,000
75 MMF	N750	7,500
100 MMF	N750	5,500

Test Voltage: 50 cycle RMS equal to peak working voltage.

Temperature Coefficient:

P100=plus 100±30 parts/million/°C.

N750=minus 750±120 parts/million/°C.

*Watch this page for release date and for advance information on other new products.*

# ERIE Resistor Limited

CARLISLE ROAD, THE HYDE, LONDON, N.W.9, ENGLAND. Telephone: COLindale 8011. Cables: Resistor, London.  
 FACTORIES IN LONDON, ENGLAND . TORONTO, CANADA . ERIE, PA., U.S.A.

# —Wharfedale—

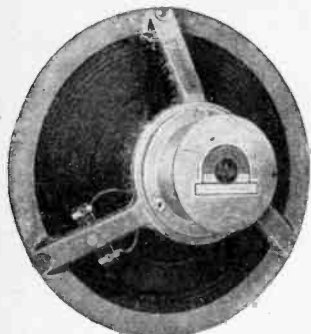

**NEW  
GOLDEN  
10 inch  
LOUDSPEAKER**

During the last six years hundreds of Wharfedale Golden Units have been supplied, and are still being supplied, to the B.B.C. and G.P.O. It was selected by reason of

its level response. The new model is fitted with precision die-cast chassis, improved spider, and Alcomax II Magnet increasing the flux density from 10,000 to 12,500. Delivery 6-8 weeks.

Speech Coil 3 or 15 ohms. Impedance. **PRICE 75/-**

Made and Guaranteed by

**WHARFEDALE WIRELESS WORKS**

BRADFORD ROAD, IDLE, BRADFORD

Telephone: IDLE 461. Telegrams: Wharfedel, Idle, Bradford



## FOR THE RADIO SERVICEMAN DEALER AND OWNER

The man who enrolls for an I.C.S. Radio Course learns radio thoroughly, completely, practically. When he earns his Diploma, he will KNOW radio. We are not content merely to teach the principles of radio, we want to show our students how to apply that training in practical, every-day radio service work. We train them to be successful!

Write to the I.C.S. Advisory Dept. stating your requirements. Our advice is free and places you under no obligation.

-----You may use this coupon-----

**INTERNATIONAL CORRESPONDENCE SCHOOLS Ltd.**

DEPT. 38, INTERNATIONAL BUILDINGS, KINGSWAY, LONDON, W.C.2

Please explain fully about your instruction in the subject marked X

Complete Radio Engineering      Radio Service Engineering  
Elementary Radio

And the following Radio Examinations:—

British Institution of Radio Engineers  
P.M.G. Certificates for Wireless Operators  
City and Guilds Telecommunications  
Wireless Operators and Wireless Mechanics, R.A.F.

Name..... Age.....

Address.....

**MODEL 44**  
*Precision  
multi-range  
Measuring  
Instrument*



### The Substandard Multi-Range Meter

This hand-made instrument has been supplied to most of the leading laboratories and research institutions in the country.

44 Ranges. 6" Mirror Scale. Moving-coil cut-out.

**ELECTRONIC INSTRUMENTS LTD**  
17 PARADISE ROAD, RICHMOND, SURREY



BY ORDER OF THE MINISTER OF SUPPLY

## Sales by Auction without Reserve of RADIO, RADAR & ELECTRICAL EQUIPMENT & COMPONENT PARTS

will be held at  
about fortnightly intervals at the  
Ministry of Supply Stores Depot

**ALDENHAM**  
**ON THE WATFORD BY-PASS**  
*Slightly to the West of "Suicide Corner"*  
**NEAR ELSTREE, HERTS**

The next of these Sales will be held on  
**WEDNESDAY, 7th MAY, 1947**  
at 11 a.m.

and others will follow on  
May 21st and June 4th

Further details of the Auctioneers

### **GODDARD & SMITH**

HEAD OFFICES & ESTATE AUCTION HALL  
22, KING STREET, ST. JAMES'S, LONDON, S.W.1

Rate 6/- for 2 lines or less and 3/- for every additional line or part thereof, average lines 5-6 words. Box Numbers 2 words, plus 1/-. Press Day: June 1947 issue, first post Wednesday, May 7th. No responsibility accepted for errors.

WARNING

Readers are warned that Government surplus components which may be offered for sale through our columns carry no manufacturer's guarantee. Many of these components will have been designed for special purposes making them unsuitable for civilian use, or may have deteriorated as a result of the conditions under which they have been stored. We cannot undertake to deal with any complaints regarding any such components purchased.

NEW RECEIVERS AND AMPLIFIERS

H.M.V. television, new 1947, table model; list price.—Box 7748. [7315]
COMMUNICATION receivers.—As soon as civilian supplies recommence we shall be at your service.—A.C.S. Radio, 44, Widmore Rd., Bromley, Kent. [4528]
COMMUNICATION receivers.—"Dale" will have them as soon as trading conditions allow.—Bemmer—Dale Electronics, Ltd., 105, Bolsover St., W.1. Mus. 1023.
SEMI-MIDGET ac/dc 3-waveband 5-valve superhets; retail price, £12/12, plus £2/15 tax; trade supplied at usual discount; also sets designed to specification; immediate delivery.
PARKER Radio Manufacturing Co., 756, Harrow Rd., N.W.10. Ladbroke 4446. [7254]
AMPLIFIERS; new 1947 model 111-E units, with triple tone controls, built to customer's specification.—Broadcast & Acoustic Equipment Co., Ltd., Broadcast House, Tombland, Norwich 26970. [6433]
OSMOR A.C.-D.C. 3-wave 5v superhet receivers, excellent reproduction and sensitivity, attractive cabinet, early delivery, shipping waveband if required; write for literature; trade enquiries invited.—Morgan, Osborne & Co. Ltd., Southview Rd., Warringham, Surrey. [7286]
OSMOR A.C.-D.C. 5v 3-wave superhet radio heart, includes (fully assembled) chassis, coil pack, calibrated dial, 2-gang, I.F.S., V.C. choke, 8-16, dropper, circuit diagrams, small resistances and condensers only required, cabinets available; trade enquiries invited.—Morgan, Osborne & Co., Ltd., Southview Rd., Warringham, Surrey. [7287]
HIGH-FIDELITY amplifier, 3 watts output, using the unique cathode follower circuit, giving vastly improved transient response, independent treble and bass boosts, easy to assemble from large diagrams, the complete kit includes valves, ready drilled chassis, all components of high grade; the kit complete with diagrams, £11/5.—Charles Amplifiers, Ltd., 1e, Palace Gate, Kensington, London, W.8. [7251]
SILVER Dragon quality communications receiver, Custom-built precision job giving the sensitivity of the communications set, plus very high quality reproduction, superb walnut console cabinet, wave coverage 9.8-2000 metres with band spread on 9.8-100 metres bands, Q.A.V.C. and volume expansion, independent top and bass boost with compensated volume control; a very versatile receiver it will be worth while investigating.—Full details from the manufacturers, Moreton Cheyney Co., Ltd., Stafford. Enquiries from overseas especially invited. [7210]
TX-R.A.F. radar "Identification Friend or Foe" transmitter-receivers, operates between 155-185 megacycles, and easily convertible for amateur use, complete with 10 valves, 2 type RK34, 1 type EF50, 4 type SP41, 3 type D1, and 20 watts motor generator, only 79/6 (carriage 4/-); Canadian type 58 Mk. 1 "Star" transmitter-receivers, complete with 8 valves, 2 sets of headphones and microphones, 3 aerials, Battle battery, etc., etc., and instruction books, all brand new, in original manufacturer's cartons, complete and ready to switch on, only £10/10 (carriage 5/-); illustrated leaflet available on application; also refer to our advertisement under "Test Equipment" offering ex-Army waver-meters.—U.E.I. Corpn., 32, St. Gabriels Rd., London, N.W.2. [7335]
RECEIVERS, AMPLIFIERS—SECOND-HAND V55R communication receiver, as new; £28/10.—Box 7810. [7356]
R1155 rec., new, £11; Magnavox/P.M. 12in. £4; wee meager 500v, £6; Triplet, 13 ranges, ac/dc volts, dc m.a., ohms, £4.—Box 7428. [7198]
R1155 communication receiver, excellent condition, £14; I.F.S. transmitter receiver unit, 70/-; valves, VR40 12/6, EF54 15/-, EC52 15/-.—Box 7534. [7268]

Partridge News

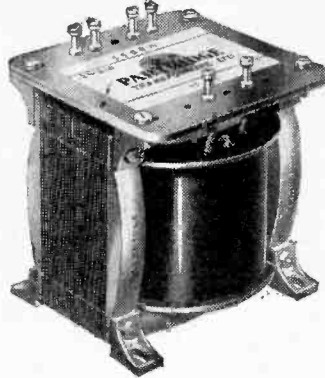

INDIVIDUAL DESIGN

PARTRIDGE Precision Built TRANSFORMERS wound to suit individual requirements now incorporate:—Silver plated turret terminals giving a low potential drop and carrying up to 15 amps. Adequate room on each for easy soldering of several external circuit wires.

Firm clamping of the laminations by means of scientifically designed pressure die-castings.

Interlocked fixing feet providing alternative mounting.

Illustrated above is mounting style "DN" which can be employed if desired on all components wound to special requirements.

AVAILABLE STOCK

A comprehensive range of mains and audio components is now available from stock, and we can despatch small quantities of these per return. We would stress that before ordering you send for our list detailing these components. Our stock range now covers almost all normal requirements, and by availing yourself of this service you will save the inevitable delay in the production of a special component.

CATALOGUE

A new catalogue illustrating various mounting styles is now available. This incorporates full data on our components, including fixing dimensions, weight, method of termination, etc. You are invited to send for a copy, issued free of charge.

Telephone:

Abbay 2244

PARTRIDGE TRANSFORMERS LTD

76-8, PETTY FRANCE, LONDON, S.W.1

R1155 R.A.F. receivers, excellent condition, R1155 for 4,000 metres; £15.
IN newly new condition, realigned and calibrated, guaranteed working order; £17/10.
CAN be supplied with output stage/power pack and loudspeaker; £27/10.
FULLY modified, as follows, becomes an all round super set with high quality output D.F. parts removed, new front panel, bass and treble boost with separate tone controls, R.C. coupled push-pull output (2-PX4s), gram input, other refinements, complete with loud speaker; £35.—Write for details.
R1155s already purchased, modified and serviced and power packs supplied.—R.T.S., Ltd., 8, Gladstone Rd., Wimbledon, S.W.19 Tel. Lib. 3303. [7003]
HALLICRAFTERS S27, 27.8 to 143mc. am-fm, s. meter, 110-230V, 15 valves, as new; £60.—Box 7443. [7244]
MCR1 receiver, complete all accessories, ac/dc, power pack and batteries; first £8; London, N.W.3.—Box 7742. [7296]
JUST, reconditioned, offers invited.—Advertiser, 105, Cheyne Walk, S.W.10. [7198]
A.C.S. RADIO, 44, Widmore Rd., Bromley, Kent, offer small selection com. sets, radio receivers and amplifiers; list free.
PHILIPS' communication receiver, speaker, mains unit, all as new; £23 or near.—Higgs, 12, Derby Rd., Caversham, Reading. [7244]
HOWARD 460 comm. recvr., 10 valves, built-in freq. Monitor, band spread, Xtal, with spkr, 0.5 to 4.5 mc.; offer over £35.—Box 7751.
COMMUNICATION RECEIVER, R.C.A. A.R.86, C as new; also all types of measuring and test equipment; write for particulars.—Box 7533.
R1155, in excellent condition; £11.—Davies, Hulmers, Great Warley, Essex. [7351]
TELEVISION G.E.C., 10x8 picture, 1939 T model, in unscratched condition, preference given to buyer in service area; £70. Wanted, R.C.A. AR88 receiver.—A. V. Spray, Ninfield Rd., Bechtill-on-Sea. [7324]
HALLICRAFTERS SX28, 6, as new, completely overhauled Webb's Radio, with 2 matched Magnavox mains speakers and power pack, giving quality reproduction.—Offers to Mould, 71, Godalming Av., Wallington, Surrey.
HALLICRAFTER comm. recvr., 11 valves, SX23, 0.5 to 34 mc/s, bandsread, crystal gate, bio, spare set valves, £40 or nearest offer; 5 watt amplifier, mike or gram operation, 600 ohms output, £30.—Write RM/GECK, London, W.C.1. [7332]
AMERICAN R.C.A. 7-valve ac 110v push-pull 6L6 paraphase amplifiers, multi-output transformer, negative feedback, gram jack, tone control, Mu-Metal mike transformer, etc., high quality equipment, 18gns complete; new boxed R.C.A. 954, 956 Acorn valves, 12/6; R.G.D. Eko type, powerful ac 14-22 volts radio tuning motors, with nutting switch, auto. clutch, forward-reverse terminals, and geared approx 60rpm, 1/4 driving shafts, new boxed, 20/-; ac transformer, 230 to 24, 14, and 6 volts, 19/-; alum sheet, 12inx12inx, gauge 16 at 2/6.—Jack Porter, Ltd., "Radio," 22-3F, College St., Worcester. Tel. 2442. [7332]
TEST EQUIPMENT
AVO 40, good cond.; £12.—Wintle, 9, Ashurst Rd., E. Barnet. [7229]
B.P.E. sig. generator, almost new; £15.—Flinta, 49, Summer Row, Birmingham. [7231]
OSCILLOSCOPE, Cossor 3314, £15; meter, 25 range, £9; s.a.e. list of other goods.—Lewis, Morgan Cres., Theydon Bois, Essex.
FOR sale, Weston type 3 analyzer, model E 772, new condition, cost £27; £20 or near offer.—W. H. P., 92, Broad Oaks Rd., Solihull, B'ham. [7270]
TWO valve voltmeters (one Salford Electrical Instrument Co., Ltd., type BW 211, the other Weston model 669).—Offers over £10 for each to Box 7605. [7211]
METER rectifiers by Westinghouse, new, Midget tubular, 3/4inx3/4in, tag ends, half-wave; 3/- each, c.w.o.; trade enquiries invited.—Stott, 87, Brixton Hill, S.W.2. [7121]
MILLIAMMETERS, desk type 0-1, suitable for conversion to multi-range test meters, 27/6; voltmeters, portable in case, 0-150, 19/6;—Wolsley Television, Ltd., 87, Brixton Hill, Tulse Hill 1244. [7252]
THANKS for waiting.—The Roberts portable combined valve and circuit analyzer ready for distribution (in rotation) in March.—Particulars and price from Sole Distributors, Messrs. Kerry's (Great Britain), Ltd., Warton Rd., Stratford, London, E.15.
EVERSHED'S Vignoles, self-contained bridge megger (500v), Varley tests, perfect; £25 or nearest offer; brand new unused Weston analyzer, £7/2, in maker's carrying case, £19; Avo valve tester, complete, in perfect order. Write for our list of radio bargains and associated products.
SNFLL Arcade, Swansea Est. 1900. Tel. 3784. [7197]

# POWER POTENTIOMETERS

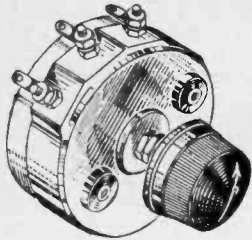

TYPE P.I.W.

Continuous Wire-Wound

**Rating :** 20 watts max. (linear).  
15 watts max. (graded).

**Ranges :** 10-500,000 ohms max. (linear).  
100-250,000 ohms max. (graded).  
100-50,000 ohms max. (non-inductive).

**Characteristics :**  
Linear, tapered, graded, log., semi-log., inverse log., non-inductive, etc.

Write for full details to :

## RELIANCE

Manufacturing Co. (Southwark) Ltd.  
Sutherland Road, Higham Hill,  
Walthamstow E.17.  
Telephone : Larkwood 3245

# BAKERS 'Selhurst'

## RADIO

18" and 12" P.M. QUALITY SPEAKERS  
8 and 15 WATT AMPLIFIERS

TIGONAL  
MAGNET



Triple  
Cone

### PIONEERS OF MOVING COIL SPEAKERS

Improved 1947 MODELS  
CINEMA Model - £8 19 6  
AUDITORIUM Model - £5 18 6

Send 2/- stamp for illustrated list to :

**BAKERS 'SELHURST' RADIO**  
75-77 Sussex Road, South Croydon, Surrey  
Telephone: GR02434 42326

**SIGNAL** generators, 100 kc/s to 50 mc/s, direct calibration in 6 ranges, accuracy 1%, ac operation 200-250 volts, first class job; 15gu; write for full specification; hire purchase arranged—Radio & Electronic Development Co., Moretonhamstead, Devon. [7201]

**NEW** boxed radar indicator, comprising 6in short afterglow green tube complete with time base, etc., 7 valves, ideal for oscillograph and television service, cost approx. £35; our price £6/10; p. and p. 10/- extra.—Pal Radio. 142, Crouch Hill, London, N.8. Mou. 4463.

**WAVEMETERS**, ex-Govt., class D, No. 1 Mark II ranges 1,000-4,000 kc/s, 4,000-8,000 kc/s, check frequencies at intervals of 1 mc up to 25 mc/s, oscillator crystal check, battery operated, supplied with spare vibrator, spare valve, and instruction book, brand new; £6/15, carriage paid; send for fully descriptive leaflet; also a few only less spares at 85/- (carriage 3/-).—U.E.I. Corp., 32, St. Gabriels Rd., London, N.W.2. [5910]

**NUPLANS**, the test gear specialists, now have ready No. 5, the Nuplans calibrator, a simple 2-valve circuit giving spot frequencies in all bands for generator, receiver, etc., calibration; also No. 6, the Nuplans oscilloscope, a versatile yet simple circuit with a 1-hard-valve time base; plans and details, 2/6 each circuit, from E. N. Bradley, "Whinnie Knowe," Escalls Cliff, Sennen, Cornwall. S.a.e. for details of other test gear plans. [7283]

#### NEW LOUDSPEAKERS

**QUANTITY** of 8in P.M. speakers for sale, less transformers, 5ohm speech coil, brand new; 21/- each, plus 1/- carriage.—Box 7430. [7211]

**SUPPLIES** of 5in to 15in P.M. speakers, S crystal, moving-coil microphones and stands; armature crystal and moving-coil P.U.s; all components including matched resistors and valves available for high fidelity amplifiers and receivers and W.W. circuits; we stock only the highest grade components.—Write Rogers Developments Co., 15, Lincoln Rd., Plumstead, S.E.18, or phone Wood 4147.

#### LOUDSPEAKERS, SECOND-HAND

**BAKER'S** P.M. auditorium spkr, 12in, new; £4/10-70, Farm Fields, Sanderstead.  
**HARTLEY-TURNER**, model 215, brand new, £7/15.—Seymour, 19, Parkhurst Court, Holloway, N.7. [7292]

**VOIGT**, as new condition, £17; Triometer (megga), new, £11.—Warburton, 9, Troy Grove, Kings Heath, B'ham, 14. [7005]

**HARTLEY-TURNER** 215, baffle, perfect, £7/5; also Qual amp and power pack.—Smith, 18, Louvaine Rd., S.W.11 [7295]

**VOIGT** loud speaker, new condition, complete with corner horn unit; £22/10.—"Newlands," Flackwell Hth., Bucks. Bourne End 851.

**INFINITE** baffle corner deflector with broad-cast and acoustic 12in P.M., twin cone unit, list £15/5, hardly used; £13 or offer.—Box 7743. [7197]

#### VALVES

**RADIOGRAPHIC, Ltd.**, 66, Osborne St., Glasgow, C.1.

**TRANSMITTING** valves.—Have available the following types:—

RK25 RK60, RK65, 6A07/1852, 843, 865, 841, 832, 803, 872, 837, 813, 805, 955, 954, 6AB7/1853, 814, 836, 250TH, 100TH, 811, 9003, 9002, 829, 838, 860, 956, 800, 830, 815, 50TH, 282A, 832A, 50V6GT, 6L6M, 35T, 24G, T240, T200, 6X4, RK20, 1625, 907. All new and unused, guaranteed. Send s.a.e. for price list.

**RADIOGRAPHIC, Ltd.**, 66, Osborne St., Glasgow, C.1. [7288]

**ACORNS**, 956s, 17/6 each; 144s, 128A7s, 12A6s, 128J7s (metal), 6SN7s, all new and unused, 7/6 each.—Box 7608. [7278]

**HAMS** disposal, quantity of 606, 6AG5s, 10/6; 9002, 9035, 9/-; post paid.—9, Richmond Terrace, Galeshead-on-Tyne. [7269]

**VALVES**—Is your work held up for valves? If so, we may be able to help you; we have large stocks of all types available at list prices; send for monthly lists.—Scott's Valve Service (Dept. D), 14, Gardner St., Brighton.

**FRITH RADIOCRAFT, Ltd.**, the Leicester Specialists, offer from their comprehensive stocks: Over 5,000 receiving and transmitting valves including many difficult types. Wearrite, Labgear and Atkins coils, most types, 3/- to 4/6 each; L.M. and S. s'het coil packs, 39/6; leaflet post free; 100% tried and tested designs for s'het 3-wave tuner, 5v A.C.-D.C. s'het midjet, 2/6 each; Serviceman's parcels of small condensers and resistors, £1 per 1/2 gross; all-wave S.M. dials, 7in x 4in, with glass and escutcheon, 12/6; Woden diecast output transformers, 6,000 and 10,000Ω. A to A, C1, 3-15Ω sec., 30v, 39/6; also most Woden types as maker's list; wide range of Eddy-stone, Raymart and Labgear components from stock.

**FRITH RADIOCRAFT, Ltd.** Churchgate, Leicester. [7193]

## DON'T MISS THESE!

**Special Offer**—Cabinet Speakers, size approx. 10in. x 10in. x 6in., fitted with Goodman 8in. P.M. chassis, and volume control, low impedance, originally £3 17 6. Cabinets are slightly marked, reduced to £3.

#### TEST EQUIPMENT.

Universal Avo Minor, 22 ranges, £8/10/- Taylor 120A Junior AC/DC, 21 ranges, £8/10/- Taylor 90A 1,000 ohm/volt AC/DC, 40 ranges, £15 15/- Walsall Model 845, 2,000 ohms per volt with lux ohms range, £14/6/8. G.E.C. "Selectest" AC/DC, 1,000 ohms per volt, £21. Hunts Capacity and Resistance bridge, 0.00001 mid. 50 mid. Power Factor 50%, 50 ohms to 5 meg. insulation test, £18/18/- Mullard Capacity and Resistance bridge, 10m. mid-10m. and 10 ohms—10 megohm power factor, £15/15/-.

#### B.P.L. SIGNAL GENERATORS.

Frequency Ranges, 100-250, 250-650, 650-1,600 kc/s. 1.6-4.5, 4.5-12, and 12-30 mc/s. Accuracy of calibration 1%. Internal modulation 400 cycles, 6 step multiplier and attenuator. £21. A.C. Mains 200/250 v. or 105/115 v. 50/60 cps. also a limited quantity of Taylor 65B Signal Generators A.C. 200/250 v. £15/10/- For orders placed immediately

#### VALVE TESTERS.

Taylor 47A/8 latest model covering tests on all modern valves. Incorporates also AC/DC multi-range meter giving A.C. and D.C. volts, 3, 15, 150, 300 and 600 v. D.C. M.A. 0.6, 6ma, 30, 150, 1.5 amp. Ohms Ranges. 0.5-1,000 ohms, 50-100,000 ohms with internal batteries, 500-1 meg, 5,000-10 meg with external batteries. £23/10/0. Complete with instruction booklet.

#### TRIX AMPLIFIERS.

Model TP633B, 30 watts, A.C. mains 200/250 v. low and high impedance outputs and fitted with Garrard gram unit, incorporating auto stop magnetic pick-up, £59/10/-. Model TP633B (R.C.) as above but fitted with Garrard 8 record automatic changer. £73 5/-.

Please send your orders and enquiries for our immediate attention. We despatch goods wherever possible the day we receive your order. These are securely packed against damage. We regret we cannot send these items C.O.D., owing to the weight, but shall be pleased to send against C.V.O. Please include extra for postage and packing.

## VALLANCE'S

144 BRIGGATE, LEEDS, 1



Designed by engineers for engineers, the Solon Electric Soldering Iron gives neater, cleaner, more efficient work in less time. The heating element is right inside the bit, giving constant heat at the point — where you want it. All internal connections housed at end of handle—away from heat and easy to get at. Complete with 6ft. of Henley 3-core flexible. Made for the following standard voltages:—200/220, 230/250.

Made in England

Model shown is a standard 125 watt round pencil bit Solon. Other sizes and types available.



Y. HENLEY'S TELEGRAPH WORKS CO. LTD  
51/53, HATTON GARDEN, LONDON, E.C.1.

**SURPLUS** new boxed valves, P×25, 3V/ pair; 955, 1R5, 3Q5, 1L1, each; 3in CRT, ECR30, 50/-; 2B, Heathill Ave., Grays. FOR sale, 9in television CRT, Mazda CRM91. nos. in sealed makers' cartons, £8/15; 2nd hand focus scanning and deflection coil assemblies, £2/10; rubber masks, 15/-—A. Gordon Galloway & Co., 120a, Myddleton Rd., Bowes Park, London, N.22. Bowes Park 3472.

**DYNAMOS, MOTORS, ETC.**  
**RUNBAKEN** charger, 72 cells max., as new, £35; offers.—Dickinson, Dorkdyke, Lincoln.  
**ROTARY** converter, 220 D.C./240 A.C., per-rectified condition, £12/10; transformer, 110 A.C./230 A.C.—Ellam, 103, Torrionno Avenue, Kentish Town. [7252]

**ROTARY** converters (2) for sale, one 100 W. wait, one 600 watt, both good condition; Best offer over £10 and £15 respec., to Randal, Lodswoth, Sussex. [7284]

**ALL** types of rotary converters, electric motors, battery chargers, petrol-electric generator sets, etc.—WARD, Lordscroft Works, Haverhill, Suffolk. Haverhill 201.

**E.D.C.** rotary converter in silence cabinet and filter, 230v d.c. to 230v 50 cycles a.c., 200w, suitable for radio, gram, or television, £10; also M.L. rotary converter, 230v d.c. to 500v d.c., 200mA, £7/10.—Martin, "Wannock" 73, Retland Ave., Southend.

**GRAMPHONE AND SOUND EQUIPMENT**  
**S.T.C.** 4021 microphone, brand new, in plush case; offers.—BM/SINE, London, W.C.1.

**FLOOR** model record player, ample tone space, Collaro unit, cabinet polished; £15.—Strange, 16, Carnarvon Rd., Letton, S.W.10. [7276]

**RECORDING** machines, recording amplifiers, R.B.S.R. amplifiers and turntables, discs, styl trailer needles, all recording accessories.—Bristol & West Recording Service, 79, Old Market St., Bristol. [7206]

**INDUCTION** motor with Rothelmal Senior p.u., pressure adjustment, 1-25oz, vibration mounted, £5; also B.T.H. needle arma- ture n.u., less bobbin, £1.—88, Mysore Rd., S.W.11, Bal. 6382. [7298]

**ARMSTRONG** EXP83, 12in Goodman P.A. speaker, H.M.V. playing desk, all post-war models in perfect condition; £35.—A. Cymbrkiewicz, 1, St. Stephens Gardens, W.2. Tel. Bay. 0011, after 6 p.m. [7207]

**COILS** for W.W. tone control and filter cir- cuits (Brierley and Hartley spec.); high fidelity, mic. line and output transformers; s.a.e. full list.—R. Clark, 30, Langland Green, Stanmore, Middle. Wor. 5321. [6971]

**NEW** radiogram cabinets in beautifully finished walnut, motor board size 32in by 17in, sold either singly or in quantities to holders of timber licences.—Apply L. Marcus, Ltd., 75-77, East Rd., City Rd., N.1. Tel. Cle. 2462. [7219]

**FOR** sale, recording unit cutting machine, German made, 7.5, 15w amplifier, 6 pre- amplifier, 2 microphones, crystal and mag- netic, ear phones, crystal adaptor, portable gramophone, 6v accs., etc., all perfect work- ing order; price £100.—Apply 33, Cross St., St. Annes-on-Sea, Lancs. [7301]

**PORTABLE** recording equipment: M.S.S. recording machine, 20 watt amplifier new, from stock; Blank discs cutting needle- trailer needles, microphones, lightweight pick- ups, matching transformers, speakers, etc.; trade enquiries invited.—Sound Discs (Sup- plies), Ltd., 83a, Bold St., Liverpool. [6964]

**1947** quality record reproducers, amplifier and radio chassis, gram motors, pick- ups, speakers, micrograms, players, etc.; lowest prices in the trade; s.a.e. for detailed list; special this month, Universal amplifiers, 12 watt, 10gms. 15/-, £14/10.—Radio Un- limited, 16, Carnarvon Rd., Leyton, E.10.

**TECHNIFON**, Ltd., manufacturers of direct T disc recording equipment and accessories. Precision built traverse gear complete with first class quality cutting head, £15/15; de- livery 3 wks.; s-sided 12in blank discs still available, 3/- each; for all lightweight pick- ups using push in stylus, our h.f. type P.T. sapphire stylus now available, 9/2 inc. P.T. postage and packing extra.—Technifon, Ltd., 99, Belgrave Rd., London, S.W.1. Vic. 8814.

**NEW MAINS EQUIPMENT**  
**MAINS** transformers, 750.0-350, 200ma, 4v and 6.3v L.T., 230v input, 65/-; 350.0-350, 100ma, 5v L.T. and 6.3v L.T., 230v in- put, 27/6; aluminium sheet, polished half hard, 22 gauge 1/4, 18 gauge 2/-, 16 gauge 3/- sq ft; duralumin tube, 1/2in, 10ft, 4/-, all postage extra; transmitter and amplifier racks built to your requirements; enquiries, and stamp for component list.—Fanthrope, 6-8, Hepworth's Arcade, Hull. [7274]

**TRANSMITTING EQUIPMENT**  
**FOR** sale, late G5QI transmitter, complete 3- stage, with power pack; prefer someone within distance; see it; price £40.—Coombes, "Faraway," Otterton, Devon. [7368]

# ELECTRADIX Stocktaking BARGAINS!!

We offer below some special stocktaking bargains at greatly reduced prices for this month only.

**HEADPHONES.** Ex-G.P.O. single L.R. Receiver type, S.G.B., with headband and cord, lightweight with bakelite case and cap, 5/- each, or 50/- per dozen.

**BATTERY superseder.** H.T. D.C./D.C. for radio receivers, 6-volt input, 110v. 15 m.a. output, 12 volts input, 230v. 30 m.a. output, ball bearings, reduced to 55/-.

**D.C. FANS.** 110-volt Oscillator type, on table stand with 12in. blade, 35/-, carriage and packing at cost.

**TELEPHONES.** G.P.O. wall type Telephone constructor's parts with wiring diagram, comprising cabinet with magneto bell, magneto hand generator, bracket mike, transformer and condenser, switch hook and contacts, single receiver, old price 30/- each, or 50/- pair. Special offer for this month, 35/- per pair.

**BUZZERS.** The Tiny Townsend high note W/M Buzzer, the smallest Buzzer made; all in good condition, 5/- each.

**MICROPHONES.** Hand mikes in moulded bakelite case, latest model G.P.O. inset, 4/6. Tannoy hand mike, as illustrated, multi-cell carbon type, metal case with neat switch in handle for sports meetings and announcements, reduced to 12/6; special transformer, 7/6. G.P.O. microphone insets, 2/6.

**SEND-RECEIVE Hand-com.** All-metal field type, the famous No. 16 Govt. pattern as used in field telephones, mike and ear-piece with damaged finger switch, reduced to 5/- each, no cord supplied. 4-way ex-G.P.O. Cord, 5ft. long, 2/6.

**THREE 5FT. Fluorescent Tubes** only, each with trough. Can be seen at our Battersea Showroom, they are a callers bargain only.

**INDUCTOR ALTERNATORS.** 400 watts, beautifully made to Government specification, totally enclosed single or 3-phase 50 cycle 230 volts 4-pole, ball bearings speed 2,800 r.p.m. need 6/8 volt separate excitation; as new, £8/10/-.

**MOTORS.** D.C. Fan Motors, 110 and 220 volts, large bulkhead type, 35/-. Small universal A.C./D.C. 1/20 h.p. motors for sewing machine conversion, 230 volts, 8,000 r.p.m., with flange, flat enclosed type, £4. 1/50th h.p., 3,000 r.p.m. universal motors, 230 volts, £3/10/-, 1/27th h.p. Universal motors, 230 volts, 4,000 r.p.m., with 4-hole base, £3/15/-, 110-volt D.C. shunt wound motor K.B.B., protected type, 1/100 h.p., 2,000 r.p.m., with 20/1 reduction gear, mounted on C.I. base, 30/-.

**SPARK COILS,** large 4in. coil on pol. wood base, in good condition, heavy contacts, £10/10/-, 8in. coil on base, £18/10/-; both for 12-volt D.C. battery operation. Mercury Interrupter, 110 volts D.C., 50/-, 3in. spark coils, ex-G.P.O., 6/12-volt coil, 25/-.

**MAGNETS.** D.C. Electric magnets, weight 10 oz., lift on 2 volts, 1 1/2 lb., 4 volts 3 lb., 6 volts 4 lb., new surplus, 7/6 each. Permanent powerful flat bar magnets, 2 1/2in. x 1in. x 3/4in., drilled 2 holes each end, for any pole pieces, 2/- pair. A.C./D.C. The mains magnets, 2-pole, 220 volts, 7/6. The wonder Midget magnets, AlNi perm steel disc, 1/2in. dia., 3/4in. thick, with 1/16in. centre hole, 3/6 each. Large stock of Horseshoe magnets. Send for special Magnet Leaflet "W".

**SWITCHES.** Dewar key panel type 8-pole C.O. flush fitting, 5/-, Yaxley 3-pole 3-way, 3/6; 8-pole 1-way, 3/6. D.P.C.O. toggle switch, 250 v. 1 amp., flush panel, 3/3, 8-way Lucas switch box, 3/6; 6-way, 3/-.

**ELECTRADIX RADIO**  
214, QUEENSTOWN ROAD, LONDON, S.W.  
Telephone: MACaulay 2159

**TRANSMITTERS** T33 and No. 9, 2,000v power units, H.R.O.s and Eddystones at less than tenth of component values.—24, Kings College Rd., N.W.3. Primrose 4806. [7310]  
**COMPONENTS SECOND-HAND. SURPLUS**  
**SOUTHERN RADIO'S** Wireless Bargains:—

**LATEST** Radio Publications: Radlo Valve Manual, equivalent and alternative American and British types with all data, 3/6; Radio Circuits, fully illustrated, receivers, power packs, etc., 2/-; Amplifiers, fully descriptive circuits, 2/-; Radio Wave Handbook, 2/-; Manual of Short Wave, 2/-; Test Gear Construction Manual, 1/6; Radio Pocket Book formulas, tables, colour code, etc., 1/-; Ten Hows for Radio Constructors, 1/-; Bulgin Radio Service Manual, 2/6; Radio Constructors Manual, 3/-; Radio Resistor Chart colour codes at a flick, 1/-; Radio Reference Hand- book, cloth bound, comprehensive and up-to- date; Covering all Branches of Radio, 12/6; American Service Manuals, Sparton-Emerson, Crosley-Belmont (Part 1 and 2), Stewart-Warner-Fada, 12/6 per volume. Postage extra on all publications.

**YAXLEY** type rotary switches, 11-way, 5/-; resistances, assorted values, 2 watt to 1/4 watt, 20/- per 100; permanent crystal detectors, 2/6 each; aluminium panels, 16 gauge, 18in x 7in, 3/6; Cutler Harmer rheostats, 30 ohms and 10 ohms, 4/6; ex-Government 18 Morse keys, brand new, 1/6 each (15/- per dozen); ex-Government buzzers, brand new, 1/6 each (15/- per dozen); detectors, type WX6 and W112, 1/- each (10/- per dozen); Luftba adjustable hole cutters for use on metal, wood, plastics, etc., 5/- each.

**LATEST** ex-Government purchase: Miniature communication receiver (M.C.R.I.), A.C.-D.C., complete with power pack phones, aerial, etc., for use on all voltages 20 to 3,000 metres, 5 valves, brand new in original cartons, £10/10, carriage and packing 5/6 extra; all goods advertised are postage extra.

**SOUTHERN RADIO SUPPLY Co.**, 46, Lisle St., London, W.C. Gerrard 6653. [6981]  
**CIRCUITS** and coil packs (and other com- ponents)

**DORSET** superhets, 3-wave 5v a.c. or a.c.-d.c., 4v all dry battery, manuscripts 5/- each; the best and most comprehensive set of drawings and instructions on the market; genuine 5/- worth of information, theoretical sheet only of any above circuits, 5/- wave, set tested, guaranteed.

**COIL** packs—3-wave, set tested, guaranteed, available in any 3 ranges of P type coils, 37/6 each, with circuit; please state if a.c., a.c.-d.c., or battery and bands required; (standard 19.49m, 200-550m, 1,000-2,000m). Write Weldona Radio Accessories, Ltd., Swanage.

**OFFERS**, 168 Belling Lee plugs and sockets, 5-pin, 72 radio two-pin.—Box 7449. [7259]

**N** carriage extra—89, Manor Rd., Itchen, Southampton. [7204]

**UNIVERSAL ELECTRONIC PRODUCTS**  
**(G8UJ)**, 36, Marylebone High St., London, W.1. Tel. No. Wel. 4058

**MINIATURE** coil packs, 4 1/2in x 2 1/2in x 2in iron cored coils, highly efficient, two types, 1 long, medium and short waves, 2 medium and two short waves, with diagram, 39/6; Weymouth coil packs, complete with circuit, 36/6.

**SLOW** motion gearbox drives, a precision built job, 2 ratios, 9-1 and 80-1, 15/6; "P" type coils, full range at 3/- each.

**R1155:** If you are not satisfied with the performance of your set let us convert it into an efficient communications type receiver. We have now a special department dealing exclusively with these sets and can offer quick service. Quality amplifiers a speciality. Transmitters, receivers, etc., built to specification.

**MANY** new items for the serviceman and amateur constructor appear in our new lists.—Free on request from Frith Radiocraft, Ltd., Leicester.

**SILVER** plating sets for tuning conds., wire, S coil holders, valveholders, small parts; 3d. stamp for illustrated folder, materials, 1/-.—Argenta (E), 40, Harrogate Rd., E.9.

**CLYDESDALE** for bargains.—Ex-R.A.F./C.R.N. radio equipment; send now for latest lists; receivers, amplifiers, loud hailer, I.F.F. units, milliammeter, voltmeters, etc., at remarkably low prices.  
**CLYDESDALE** Supply Co., Ltd., 2, Bridge St., Glasgow, C.5. [7238]

**BASIC** kit for 4-valve A.C. TRF, M and L receiver, including mains transformer, smoothing, 6in loudspeaker, polished oak cabinet, 12in x 8in x 7in, coils, 2-gang condenser with drive valves, drilled chassis; £7/10.—Box 7604.

**TRANSFORMERS** for every purpose, highest grade workmanship, competitive prices, immediate delivery; test gear trans. for bridges, oscilloscopes, valve testers, etc.; list.—Radio Services, Field St. Works Blackpool. Tel. 1250

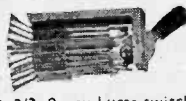

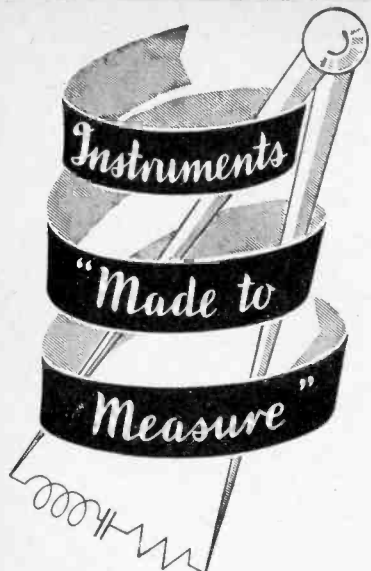

FOR ALL ELECTRICAL AND COMMUNICATION ENGINEERS



Quadrant Works, Finchley Lane, Hendon, N.W.4  
Telephone: Hendon 3682/3230

**LASKY'S RADIO**

**THIS MONTH'S SPECIAL OFFERS**

**MOVING COIL AMMETERS**, 2" flush panel mounting, first grade, 0-10 amps. (shunt can be removed). Boxed. New and unused. Price 12/6 each.

**EX-AM PRESS BUTTON CONTROL BOXES**, new and unused. Consisting of 5-way press button unit, 4-pole 3-way tran/rec switch indicators and 2-pin plug and socket. Price 8/6 each.

**SOLID DIALECTRIC, VARIABLE CONDENSERS**, .0005 and .0003 mfd. 2/11 each.

**YAXLEY TYPE SWITCHES**, 4-pole, 2-way, 2-bank. Price 2/6 each.

**YAXLEY TYPE SWITCHES**, 2-pole, 5-way midget. Price 2/6 each.

**P.M. MOVING COIL SPEAKERS**, 3 ohm. voice coil, less transformer. 5", 19/-; 6", 21/- (6" with O/Trans., 27/6 each).

**6", 21/6 (6" with O/Trans., 27/6).**

**EMERGISED MOVING COIL SPEAKERS**;

5" with trans., 1,000 ohms. field, 3 ohms., V.C. 29/6.

8", less trans., 1,500 ohms. field, 3 ohms., V.C. 29/6.

10", with trans., 5,000 ohms. field, 3 ohms., V.C. 39/6.

**REAL MIDGET 2-GANG CONDENSERS**, .0005 mfd. ceramic insulation and trimmers, dustproof transparent Perspex cover. Size 1" Length 2" x depth 2" x width 1 1/4" spindle. Price 14/6 each.

**MEDIUM AND LONG WAVE T.R.F. COILS**, AE and OSC., high gain, with reaction. 3/6 per matched pair, circuit included.

**6 and 12 VOLT VIBRATORS**, 4-pin UX base, 9/6 each. Red Indicator lamp holders M.E.S. panel mounting 1/6 each.

**BFO AND I.F. UNITS** as previously advertised.

**ELECTROLYTIC CONDENSERS**;

8-4 8mfd., 5/6; 8mfd., 4/-; 4 mfd., 2/11. 500 volts working. T.O.C. Pico-Pack, 20 mfd., 12 v.w., 2/6; 10 mfd., 25 v.w., 2/6. Tubular base, 50 mfd., 12 v.w., 2/-; 25 mfd., 25 v.w., 1/9; 250 mfd., 12 v.w., 2/6.

Tubular cardboard, 8 mfd., 150 v.w., 1/11; 15 mfd., 250 v.w., 3/6; 16 mfd., 450 v.w., 4/9; 8 mfd., 450 v.w., 4/9.

**6,000 RADIO VALVES OF ALL TYPES, AT OFFICIAL LIST PRICES.**

We have space for only a few items from our extensive stocks. Send list for our current list and bulletin.

Terms, Pro Forma, C.O.D., or cash with order (no C.O.D. under £1). Orders over £5 post free. All goods covered by our unconditional guarantee. It will pay you to pay us a visit.

**LASKY'S RADIO**

370, Harrow Road, Paddington, W.9

(Opp. Paddington Hospital)

Telephone: CUNNINGHAM 799

**RADIO CLEARANCE, Ltd.**, 27, Tottenham Ct. Rd., W.1. Mus. 9188.  
U.H.F. receivers, ex-R.A.P. type 1481, range 66-86 mc/s, 10, 6.5v valves, sequence, R.F. (VR65), mixer (VR65), osc. (VR66), 3 I.F.'s (VR53s), b.t.o. (VR53), det. and a.v.c. (VR54 double diode), A.F. (VR57), output (VR67), beautiful 0-100 6in s.m. dial, tuning meter, R.F. and L.F. gain controls, a.v.c./man/b.t.o. switch, I.F. 12mc/s, jack sockets for mon. and line outputs, size 19in x 10 1/2 in x 10 1/2 in (fits standard 19in rack), ideal for conversion to cover 5 metres, etc., requires power pack 250 and 6.3v, all brand new, supplied complete with all valves, in original wooden cases with hinged lids (1ft 10in x 14 1/2 in x 11 in); price £12/12.

**MAINS trans.**, outputs 3kv 30ma (5kv no load), 300v 250ma, 4v 20a, 6.3v 4.2a, 4v 1.2a, for c.r.t., 3 valveholders for rectis. mounted and wired, ready for use, primary 230v 50c/s, 30/-; heavy duty smoothing chokes, 400ma 250Ω, 21/-; smoothing chokes 20H 80ma 300Ω, 12/6; p.m. speakers, all well-known makes, 2 1/2 in, 25/-; 5in, 25/-; 8in, 25/-; 8in with trans, 27/6; 10in with trans, 42/6; superhet coils M.W. ae, M.W. osc, L.W. ae, L.W. osc, former size 1/2 in x 1 1/4 in, 2/6 each; iron-cored 465kc/s trap, 2/9; set of 4, 1/3 and trap, 11/6. V.C. with switch, 5k, 10k, 25k, 50k, 100k, 250k, 500k, 1m, 5/3; V.C. less S.W. carb, 20k, 30k, 50k, 100k, 500k, 1m, 2/6; double 1m, 4/-; min carb less S.W., 1k, 20k, 100k, 200k, 500k, 2/-; V.C. wire-wound, 30Ω, 150Ω, 200Ω 500Ω, 1k, 2k, 5k, 10k, 20k, 50k, 2/6; all 5w type. Electrolytics, 8mf 450v 3/3; 20mf 50v 2/-, 50mf 12v 1/9. Mans-bridge conds., 1mf 350v 3d, 1mf 1,000v 1/3, 2mf 300v 1/-, 4mf 600v 4/6, 4mf 1,500v 5/-, all wkg. v; switches, 1p 3w 1/9, 1p 9w 2/6, 1p 6w 2b 3/-, 2p 4w 2/9, 2p 5w 2b 3/6, 2p 5w 3b short spindle 2/9, 4p 2w short spindle 1/9, 1p 9w 3b 4/-; tubular conds., .001-2.5 6d., .01-2.45 6d., 1 350v 7d. Mica conds., .0001-3.5 4d., .001-2.4 5d., .01 6d; silver micas, most sizes, 6-6,000pf 6d; ceramics, 2, 10, 20, 25, 50, 100pf, 6d; resistors, 1/4w 3d, 1/2w 4d, 1w 6d, 2w 10d, 3w 1/3, most values in stock; 3w wire-wound, 5Ω, 45Ω, 470Ω, 3.9k, 6.8k, 47k, 1/-; 10w, 50Ω, 250Ω, 500Ω, 1k, 1,200Ω, 1/6; 20w with clips, 120Ω, 200Ω, 2k, 8k, 2/-; 25w, 350Ω, 5k, 2/6; 40w 14k tapped at 2k, 3/-; bakerized paper tub, 17 250v 3d, 1 600v 6d, 100mf 12v elect. 1/-; mains droppers, 2 sliders, .2a 3/6 (1,000Ω), .3a 800Ω 4/-; U.A.F. chokes, 1/-; ceramic trimmers, 1/15pf, 3/50pf, 9d; air-spaced variable, 30pf, 3/4in spindle, 1/-; padders, 150pf, 750/1,250pf, 1/-; valveholders, 4-pin Brit. Pax 1d, Amphenol, 4PUX, 5PUX, 5P, Brit., Mazda Oct. 6d, Int. Oct. 8d, porcelain 1/P. Brit. 8d, E.F. 50, etc., Pax 6d, Micalex 7/-, ceramic 1/6; orders under 10/- to include postage. [7372]

**COULPHONE RADIO**, 58, Derby St., Ormskirk, Lancs. The return of Post Mail Order Service. Phone Ormskirk 496. C.o.d. or c.v.o. Post free over 5/-. New goods only. All goods previously advertised still available. **MAINS Transformers**: Primaries 200/30/50, 4 or 6.3 and 5v L.T.'s, 300v 60ma, 23/6; 350v 100ma, 28/6; 450v, 200ma, 45/-; 1,250-1,000-750-750-1,000-1,250-300 mA (no L.T.'s), 92/6; filament, 4v or 6.3v 6A, 16/6. **Smoothing chokes**, 40ma, 5/-; 60ma, 6/-; 90ma, 7/-; 100ma, 12/6; 200ma, 21/6. **Feeder units** with R.P. stage, "P" type coils, R.F., F.C., I.F., D.D., ready for connection to audio amplifier: Type B3, £8/15; Weymouth Superhet Coil Paaks, 36/6. **Midget I.F.T.'s**, 18/9. 2 W.B. T.R.F. coils with reaction, pr. 9/6. 3WB Superhet coils, pr. 1/16. **Rotary transformers**, 5v D.C. input, output 200v 50ma, or with 12v input 480v 40ma output, note price 15/-, Muirhead precision reduction drives, ratio 55:1, 12/6. **Bright aluminium chassis**, 16 s.w.g., 4 sides, 3in deep, 10in x 6in and 10in x 8in, 8/6; 12in x 9in, 9/6; 14in x 9in and 16in x 8in, 10/6; 20in x 8in, 12/6. **Squares**, 3in x 3in, 3d. **Belling Lea Type B terminals**, 1/-; S.G.B. phones, 4,000Ω, 17/6. **Eliminators** with trickle charger, £4/5. **Receiver constructional kits**, complete in every detail, prices include P. tax: 2WB TRF, 4v, A.C./D.C., £9; 3WB superhet, 5v A.C./D.C., £12; A.C., £12/10. **Complete kits** for Weymouth 5v A.C. or A.C./D.C. receivers also available. **Weymouth sub-assemblies** for 6A8, 5/9; for 6Q7, 7/3; for 25A6, 5/-; for 25V5, 1/6. **B.P.L.** 17 range test set, £8/17/6. **Avomitor Universal**, £8/10. **Vidor battery portables**, 4v superhet, £17/9/3. **Vidor miniature pocket portable**, £20/13. **Romac car radio** (with R.F. stage), £31. **Rothermel sapphire needles**, 12/6. **Senior P.U.**, 56/3. **Connoisseur** (with transformer), 78/8. "P" type coils, 2/9. 2g. 0.0005 tuning condensers W/T, 12/6. Send 2/6d stamp for new 20-page catalogue. [7353]



The illustration depicts our standard portable case. Finished with "New Wrinkle" Black Stoving enamel and supplied with chrome handles. The controls, with neat identification labels, are mounted on the recessed front panel. Cover and baseplate quickly removable.

These are in production —

AC/10	Home Gramo Player, 8/10 watts	£7 7 0
AC/18	Concert P.P. Gram, 10/12 watts	£11 11 0
AC/18T	As above, 2 inputs mixer-fader	£12 0 0
AC/18HG	Gram and Mic., inputs mixer-fader	£13 5 0
AC/25	Popular P.A. Gram and Mic., mixer-fader 23/25 watts	£16 16 0
AD/9	AC/DC Mic. and Gram., mixer-fader, 9/10 watts	£12 12 0
PAC/26	Combined Speaker and Mic., in case	£42 0 0

Technical data leaflets available on each; full catalogues on equipments, microphones, stands, speakers. Sixty specifications in our transformer range. Send 3d. for this wealth of detail.

**General Lamination Products Ltd.**  
294, Broadway, BEXLEYHEATH, KENT.  
Phone: Bexleyheath 3021.

**YOU can become a first-class RADIO ENGINEER**

We are specialists in Home-Study Tuition in Radio, Television and Mathematics. Post coupon now for free booklet and learn how you can qualify for well-paid employment or profitable spare-time work.

**T. & C. RADIO COLLEGE**  
North Road, Parkstone, Dorset

(Post in unsealed envelope, 1d. stamp)  
Please send me free details of your Home-Study Mathematics and Radio courses.

NAME.....  
ADDRESS.....  
W.W.59.



H.T. and L.T. rectifiers, charger kits, fluorescent chokes, no surplus goods offered. All charger kits guaranteed one year.

**SELENIUM** metal rectifiers, new small space type, 250v 60 ma for ac/dc receivers, take the place of valve rectifier, with circuit 9/6 post 5d, ditto 120v 20 ma for eliminators 7/3, ditto 120v 60 ma for U.S.A. midgets 9/6 post 5d, product of famous manufacturer.

**ELIMINATOR** kit, 120v 20 ma rectifier with transformer, 2 8mids condensers and trickle charger rectifier for 120v 20 ma eliminator, 39/6, post 10d; selenium L.T. rectifiers, well-known make, new goods, with instruction sheet, 12v 1.5 amp 10/6 post 5d, 12v 2 amp 15/- post 7d, 12v 3 amp 18/6 post 10d, 12v 4 amp 25/-, 12v 5 amp 32/6, also 12v 6 amp heavy duty type with giant cooling fins, 38/6 post 1/-; other types in stock including rectifiers for converting garage-type valve chargers to metal rectification; charger kits, 50 watt mains transformer with 12v 3 amp rectifier and ballast bulb for 2v to 12v charger, no rheostat or ammeter needed, 48/6 post 1/-, ditto with 2 amp rectifier 39/6 post 11d, also for 2v 6v only 36/-; mains transformer 75 watt with 12v 4 amp rectifier and ballast bulb for 2v to 12v charger, weight 9lb, 62/-, postage 1/-; heavy duty transformer, 150 watt with 5 amp rectifier, for 6v, 12v charger, high grade, 0.6 amp ammeter included, 24/10/6 post 1/2.

**CHARGER** kits for small radio store, guaranteed one year, for one to 20 cells at one amp, comprises 150 watt transformer, selenium rectifier and ballast bulb and holder, £4/15; ditto to 1 to 20 cells at 2 amps, £6/15, transformer and rectifier specially designed; ammeters, flush mounting, reliable and accurate 0.6 amp, 15/-, post 6d; transformer and rectifier for 2v trickle charger, 13/6 post 7d; fluorescent chokes, 80 watt, boxed and bitumen filled, 230v 19/-, and tapped 200-250v 21/-, postage 1/2.

**CHAMPION**, 43, Uplands Way, London, N.21. Tel. Lab. 4457. [7371]

**COPPER** wires, enamelled 1/4in reels, 18, 20g, 1/6; 22, 24g, 1/9; 26, 28g, 2/-; 30, 32g, 2/3; 34, 36g, 2/6; 38, 40g, 2/9; 42g, 3/6; cotton-covered, same prices. Silk-covered, 16g, 1lb 5/6; 18g, 1lb 7/-; 19, 20g, 1lb 4/-; 22g, 1lb 2/6; 2oz reels, 24, 26g, 1/6; 28, 30g, 1/9; 32, 34g, 2/-; 36, 38g, 2/3; 40, 42g, 2/6; 44, 45g, 2/6 1/2. Tinned copper, all gauges 18-42 w.t.

**LAMINATED** bakelite panels, 1/4in thick, 6in x 4in, 1/6; 6in x 6in, 2/-; 8in x 6in, 2/6; 10in x 6in, 3/-; 10in x 8in, 3/9; 12in x 8in, 4/6; ditto, 1/4in thick, same sizes, 1/-, 1/4, 1/8, 2/-, 2/6, 3/-. Polished ebonite panels, 3/4in thick, sizes as above, 2/-, 3/-, 3/9, 5/-, 6/6, 7/6 respectively; ditto, 1/4in thick, 2/6, 4/-, 5/-, 6/9, 8/9, 10/- respectively.

**B.A.** screws, gross useful sizes, 2/6; ditto nuts, 2/6 gr; assorted gross screws and nuts, 2/-; brass washers, 1/6 gr; fibre washers, 1/6 gr; assorted soldering tags, 2/- gr; assorted small eyelets and rivets, 1/3 gr; finest quality stranded and single push-back wire, 12yds, 2/3; resin-cored solder, 1/4lb, 1/-; new ex-G.P.O. hand telephone with microphone, switch and leads, 12/6; used ex-G.P.O. low resistance earphone with switch, 2/6; all postage extra, trade supplied. Post Radio Supplies, 33, Bourne Gardens, London, E.4. [7217]

**SUPREME RADIO**, 746b, Romford Rd., Manor Park, London, E.12. Est. 15 years, still the lead with component parts: 2-gang condensers 9/6. 3-gang 13/-; line cord, 60-70ft net, 20/- doz. yds.; droppers, 2 or 3, with fixing feet, 3/9; volume controls, best makers, long spindle with switch, 4/-; less switch, 3/-; 10,000Ω wire-wound, less switch, 5/5; bias condensers, 50-12 1/9, 25-25 1/9, 50-50 3/3; tubular condensers, 0.01, 1,000 V.W., 4/6 doz.; 0.05-500 V.W., 4/6 doz.; 0.1 350 V.W., 4/6 doz.; 0.2 250 V.W., 4/6 doz.; 0.25 mid. can. condensers with clip wire ends, 500 V.W., 9/- doz.; 8 mid. can. condensers, 500 V.W., 36/- doz.; resistances, well-known maker, 1/2w, 1,000Ω, 10,000Ω, 20,000Ω, 22,000Ω, 27,000Ω, 51,000Ω, 100,000Ω, 220,000Ω, 279,000Ω, 560,000, 1 meg, 1 1/2 meg, 2 meg, all at 3/- doz.; 1w, 25,000Ω, 75,000Ω, 4/- doz.; assorted wire-wound 1 and 2w, handy sizes, 2/6 doz.; string drum drives, 3/4 sleeveing, 3/- doz. yds.; U.S.A. actual and standard valve holders, 4/6 doz.; screen caps, lead attached, standard size, 9/- doz.; Ivorine dials, 3/4in x 4in all-wave, 1/6, 6x6 2/6; glass dials, all-wave, 8in x 5in, 3/6; midget chokes, 60 ma 6/-, 100 ma 10/-; midget speaker trans, 4/6; coils M and L, 8/6; med only, 5/-; speaker trans, pen, 5/9; 30w PP, 6,600Ω-15Ω, 20/-; solder, 1/2lb 4/-; P.B. wire, stranded, 4/6 100ft; 1/4in black tape, 1/2lb, 2/-; Weymouth coil tape, 1/2lb, 4/6 etc., etc. All goods "CLEARANCE" lines; cannot be repeated when all sold.

TERMS, c.w.o.; no o.d.; send 6d extra for postage and packing all orders under £5; 2/6d stamp all enquiries and price list. [7291]

# ARMSTRONG

## Model EXP83

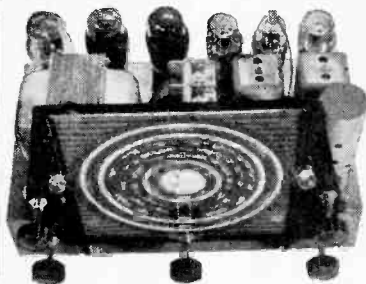

### ALL-WAVE 8-VALVE SUPERHET CHASSIS

incorporating wave band expansion. Large glass scale treble boost control. Gram. switching. High quality push-pull output gives 10 watts audio. For 100-250 v. A.C. mains.

Price 14 gns. plus tax

## Model UNI-83

### ALL-WAVE 8-VALVE SUPERHET CHASSIS

incorporating wave band expansion, e.g. the 16-50 m. band covers just over 20 inches on the large glass scale, treble boost control, gram. switching, all controls work on both radio and gram., high quality push-pull output giving 6 watts audio. For 200-250 v. D.C. or A.C. mains.

Provisional Price 14 gns. plus tax

## \* Model EXP53

### ALL-WAVE 7-STAGE RADIOGRAM CHASSIS

This new radiogram chassis incorporates wave-band expansion on all bands. Volume and tone controls work on both Radio and Gram. 4½ watts R.C. coupled output. Supplied complete with full size loudspeaker. This chassis has a lively performance, good quality reproduction, and represents excellent value. For 200-250 v. A.C. mains.

Price with speaker £13 plus tax

\* Owing to the National Emergency and the consequent loss of production we may be compelled to suspend this Model temporarily. We shall, however, do everything possible to avoid this.

## Model AMP14

### HIGH GRADE AMPLIFIER CHASSIS

Two inputs, bass compensating circuit, treble boost control, 14 watts push-pull output preceded by 4 triodes.

Price 13 gns.

Demonstration Sets are now available for interested callers to hear and illustrated technical specifications are now ready.

**ARMSTRONG WIRELESS & TELEVISION CO. LTD.**  
**WARTLERS ROAD, HOLLOWAY, LONDON, N.7**

\*Phone: NORth 3213

**SOMETHING** special for constructors and "hams"; huge purchase of A.M. S.M. drives, 3in embossed plate, 1in coupling, 2 coloured knobs, fine strong job, 5/3 complete or 10/- matched pair, post incl. also brand new 500 microamp (1/2 m/a) M.C. 2in type meters, 21/-; c.w.o.; send s.a.e. for interesting list of components, etc.—Dept. W., Barnes Radio & Wholesale, 2, Elmdate Rd., Penn., Wolverhampton. [7359]

**ROTARY** transformers, brand new, ex-Govt. R stock, with 6v input, output 200v at 50ma continuous, or 150v at 80ma up to three hours, with 12v input, output 480v at 40ma continuous or 400v at 80ma up to three hours, size length 7 1/2in, height 3 1/2in, weight 6 1/2lb, ideal for car radios, mobile amplifiers, etc., original price £7/7, each 25/-; midget m.c. wave, L.R.I. coils, high gain, 5/-; m.l. wave, with reaction, circuit, 7/6; m.l. m.l. wave, iron cored, adjustable cores, circuit, 10/6; a.m.l. er. and osc. coils, circuit, 10/6; Weymouth midget i.f.s. iron core, 465 kc/s, per pr. 18/9; standard i.f.s. 465 kc/s, per pr. 15/-; standard ditto, 2 mc/s, each 3/6; Weymouth all-wave coil pack, 36/6; 2-gang condensers, 0.0005mid, 12/6; ditto 0.0001mid, 7/6; Tiny Tim ditto, fitted trimmers and perspex dust cover, 2in x 1 1/2in x 1 1/4in, 17/6; speakers, minus tran., p.m., 5in, 21/-; ditto p.m., 6in, 27/-; coloured ironme dials, s.m.l. wave, 4x3 1/2in, 2/-; 5x5 1/2in, 2/6; 6x5 1/2in m.l. wave, 1/6; slow motion drum drive, 3/-; epicycle drives, 3/3; Rothemel Senior piezo crystal pick-ups, 56/3; Avo capacity bridge, £11/11; 61.6 output, p.p. trans, heavy duty, 6,600 ohms, 15 ohms, 16/6; Ferranti ditto, p.p. output, 2/1, 15/-; Varley heavy duty, p.p. input, 2.5, 2.5/-; screened, rubber covered twin circular cable, 2/- 9d; block condensers, 9 plus 8d, 500v, 24 plus 24mid, 30v, 8/-; 8mid, 150v, 2/6; 50mid, 12v, 2/-; 25mid, 25v, 2/6; midget cabinets, cream and green, 13in x 7in x 6in, 40/-.

**O. GREENLICK**, Ltd., 34, Bancroft Rd., Cambridge Heath Rd., London, E.1. Tel. Stepney Green 1334. [7375]

**CHARLES BRITAIN RADIO, Ltd.**, offers attractive bargains this month. Coil packs: Radiomaster 3-wave band with trimmers, padders, and full circuit diagram, 27/6 ea.; Douglas long and medium wave with trims, pads and diagram, 22/6 ea.; individual coils, midget iron cored wound with Litz wire, h.l. aerial, and oscillator, short, medium and long bands, 2/6 ea.; Varley mains transformers, 4 and 6v types, 30/-; Special offers: Moving coil meters, 2 1/2in scale marked 0-3v, 0-1.5v, 0-60ma., 0.5,000 ohms, will form basis for first class test meter, 25/- ea.; 5in speakers, less trans., 14/6 ea.; ex-l.A.F. indicator units, these are complete with a 6in electrostatic cathode ray tube and a time-base using several EF50 and EB34 valves, £6/10 ea.; can only be sold to callers; moving coil mikes with metal grille undamaged, 1/- ea.

**BARGAIN** parcels: No. 1, 36 assorted tubular condensers, 0.001-1mf, 10/6; No. 2, 72 assorted 1/2, 1/4, and 1watt resistors, 100ohm to 1meg, 12/6; No. 3, special constructor's parcel containing resistors, condensers, valveholders, switches, tag bars, fixing strips, 4 and 6 b.a. nuts and bolts, grid clips, fuse holders and socket strips, a real bargain, £11 only; No. 4, power pack parcel, 6-12v charger using mains dropper, choke and metal rectifier, 18/6.

**NEW** purchase: Brand new ex-Govt. M.C.R.1 miniature resistance movement radio, 20-3,000 metres, complete with power pack, 4 plug-in coils, phones, etc., 97-250volts a.c./d.c. or from dry batteries, £7/19/6 (post 1/6); batteries for same, 16/6 each extra (post free). Send for our list giving details of our many goods too numerous to advertise.

**TERMS**, cash with order or c.o.d. over £1; send for latest list "W."—Charles Britain (Radio) Ltd., Radio House, 2, Wilson St., London, E.C.2. Tel. Bis. 2966. [7303]

**NEW** STC metal rectx, F.W. bridge-conn., 1/2 damp-proof finish; list prices, makers' ratings, 12v 1a 11/-, 1.5a 14/-, 2.5a 19/6, 4a 23/-, 5a 31/-, 8-10a 37/9; (last two post 1/-); 24v 4a 42/1, 8a 64/10, 16a 126/5, 30v 5a 57/10, 50v 5a 81/6, 95v 5a 151/3; all plus carr. 1/3; transformers, famous make, 200-250v, sec. tapped for 6-12v charger using 12v 5a rect., 48/-; carr. 1/3; 12v, 8-10a rect., 130ma, 4/-; 1st gde. slider res., 150w 75/-; carr. 2/-; 1st gde. slider res., 150w all values; steel charger cases, 14in x 6in x 5in h., v. well made, vent., w. lid, h. ex. for up to 12v 4a chargers, 9/-, post 1/-; steel boxes w. hinged lid, 8 1/2in x 8 1/2in x 6 1/2in h., 7/-, p.f. (not new); technical queries welcome; s.a.e. please; trade supp.; for workshop or den. new Mazda 40w fluor. lighting units, comp. ready to sw. on, £5/19/6 plus carr. (see Diallist, Sept., '46)—Pearce, 66 Gt. Percy St., London, W.C.1. Nr. Angel. [7267]

## Woodwork by Lockwood

We are Specialists in the Manufacture of high-class Precision Woodwork for the Radio and Electrical Trades and we shall be pleased to receive your enquiries for the following:—

RADIO CABINETS  
INSTRUMENT CASES  
BAFFLES - HORNS  
TRANSIT CASES  
LABORATORY  
FURNITURE.  
FITMENTS, ETC.

Timber Licence Required



& COMPANY

67, Lowlands Road, Harrow, Mdx.

Phone: BYRon 3704



Be WISE  
and PATIENT

**WE** APOLOGISE to those who have been waiting months for replies. Our post-war plans have been frustrated so far. Sorry!

**VOIGT  
PATENTS LTD.**

## HILL & CHURCHILL LTD BOOKSELLERS SWANAGE, DORSET

Available from stock:—

Schelkunoff, "Electromagnetic Waves"	37/6
Terman, "Radio Engineering"	30/-
Ghirardi, "Modern Radio Servicing"	37/6
Dahl, "Electric Circuits—Theory and Applications"	25/-
"Radio Handbook," 10th edition, U.S.A.	17/6
Hudson, "An Introduction to Electronics"	15/-
Cocking, "Television Receiving Equipment"	12/6
Smith, "Radio Designers Handbook"	10/6
Brainard — "Ultra High Frequency Techniques"	28/-

Postage Extra.

We have a large selection of English and American Books on RADIO and TELECOMMUNICATION.

CATALOGUE ON APPLICATION

**COILS**, midjet adjustable iron-cored, aer. and osc., s., m., or l. wave, 7/6 pr.; dual-wave coils, m. l. wave aer. and h.f., 9/6 pr.; i.f. transformers, 465kc/s, size lin dia.  $1\frac{1}{2}$  in high, 9/6 ea.; all above coils with circuit; miniature rotary switch, 4-pole, 3-way, 3/9 ea.—**Monochord Radio**, 235, Streatham Rd., S.W.16.

**ALIGNED INSTRUMENTS SERVICES**, 1. Colworth Road, Leytonstone, E.11. 40 **COIL PACK**: A superhet coil pack with an H.F. stage. Uses 9 iron cored coils in a 16-50, 200-500 and 800-2,000 metres circuit for 465kc/s, I.F.; complete with circuit diagram, aligned and gain tested, this coil pack enables the amateur with no signal generator to construct a 1st class all-wave receiver; price £3/10. Circuit diagram only, 2/6 post free.

**30 COIL PACK SERIES**: A famous series of precision made coil packs now too well known to need description. Superhet types: Model 10, 16-50, 200-500, 800-2,000, at 42/-; 30A, 12-30, 30-75, 75-200, at 42/-; 30B, 16-50, 200-550, at 30/-; 30C, 200-550, 800-2,000, at 30/-; 30S, 12-30, 30-75, 200-550, at 42/-, TRF types: Model 30D 16-50, 200-550, 800-2,000, at 35/-; 30E, 12-30, 30-75, 75-200, at 35/-; 30F, 16-50, 200-550, at 27/6; 30G, 200-550, 800-2,000, at 27/6. Each is complete with circuit. Circuits only 2/6.

**HIGH "Q" I.F. Transformers**: 465kc/s, iron cored, permeability tuned. For use with above superhet coil packs. Aligned and gain tested. Price 17/6 per pair.

**TUNING CONDENSERS**: 2-gang matched to all our 30 coil pack series, price 15/-; 3-gang matched to our 40 coil pack, price 17/6. These condensers ensure that correct alignment and waveband coverage is maintained. Many other interesting A.I.S. products available. Send stamp for new price list. Terms: Cash with order or C.O.D. No C.O.D. under £2. Over £5 post free. 17370

**SANGAMO** synchronous motors, self-starting, exceptionally good torque, rotor speed 200 rpm, 200-250 v.a.c., 50e, consumption 2½ wats, size 2½x2in, geared 1 rev. 20 min. can be reset to zero by friction drive from front or back, shaft  $\frac{3}{16}$ in x 1/10 to run clockwise, ideal movements for making electric clocks, time switches, etc., nickel plated finish; price 22/6 each; 12 to 1 dial trains to fit above spindle, per set 2/6; as above, with Chamberlain & Hookham synchronous motors (enclosed type 25/-; moving-coil headphones, P.M., energised by Alni magnets, 45 ohms,  $\frac{1}{2}$ in coil, ideal for mikes, miniature loudspeakers, etc. 1½in overall in bakelite cases with 5in front flange. 6/6 each.

**15-AMP. mercury switches**, enclosed bakelite tubular cases, 2½x¼in, fitted swivel saddle, connector block, etc.; 5/6 each; cash with order, post paid on all above goods; to callers only, a comprehensive stock of scientific instruments, meters, gears, relays, etc.

**H. FRANKS**, Scientific Stores, 59, New Oxford St., London, W.C.1. Tel. Museum 9594.

**HENRY'S RADIO**—We specialise in small components; PA1, PA2, PA3, PO1, PO2, PO3, Wearite coils now in stock, 3/- each; t.r.f. coils, m. and l., with reaction, and circuit, 8/6 pr; superhet coils, m., l. and s., with circuit, 9/6 pr; valve cans, standard size, aluminium, 2/- each; vibrator unit, complete, 12v input, 210-volt, 70ma output, unparallelled valve, 45/- ea.; vibrators, Mallory, 6v and 12v, 4-pin, 9/6 each; electrolytics, 8mf, 500v wkg, 4/-; 16mf, 500v wkg, 5/-; 8x8mf, 500v wkg, 6/-; 40mf, 150v wkg, 4/-; aluminium sheets, 18 gauge, 11in x 9in, ideal for chassis, etc., only 1/6 each. Our new price list is now ready; cash with order (or c.o.d. over £1); trade supplied.

**HENRY'S RADIO**, 5, Harrow Rd., Paddington, W.2. Paddington 1008-9. 17376

**COMPLETE** kit of parts for 200-250v ac/dc medium and long wave T.R.F. receiver, including valves 6K7, 6J7, 25V5, 25A6; drilled aluminium chassis 10-5-1½in, 5in p.m. speaker, s.m. drive and illuminated coloured ivorine dial (station named), Weymouth coils, and absolutely everything required to last nut, price, including P.T., £6/14/6; attractive polished wood (walnut) cabinet to suit, size 12½-7-6½in, 50/6 extra; polished wood cabinets available from 22/6 each; chassis, 16 gauge aluminium, 10-5-1½in, undrilled 4/-, drilled for 5 valves, etc., 5/-; trimmers, post age stamp type, 4-40mf, 5/- doz; bias condensers, 25mf, 25v, 1/9; Yaxley type switches, 4-pole 3-way double bank, 3/-; 4-pole 2-way single bank, 2/9; 2-pole 6-way, 3/-; mains droppers, 0.3amp, with feet and 3 sliders, 3/11; resincored solder, 4/- lb; condensers, fixed, 0.01mf, 600v, 0.05mf, 500v, 0.1mf, 350v, 4/6 doz; tuning coils, high gear T.R.F., AE and H.F., with reaction and circuit, 8/6 pr.; all goods new and unused; lists 2/- s.a.e. all enquiries; terms c.w.o. otherwise c.o.d.; postage extra.

**E. POWELL**, 19, Lidget Hill, Pudsey, Leeds.

## Specialists in

HIGH POWER - HIGH QUALITY

**PUBLIC ADDRESS  
SYSTEMS**

★  
**AMPLIFIERS**

from 150 W to 1kW

**W. Bryan Savage Ltd**

WESTMORELAND ROAD, LONDON, N.W.9

Telephone: Colindale 7131

## TRANSFORMERS & COILS TO SPECIFICATION.

MANUFACTURED OR REWOUND

**JOHN FACTOR LTD.,**

(Formerly Stanley Cattell Ltd.),

9-11 East Street, TORQUAY, Devon

Phone: Torquay 2162.

## QUARTZ CRYSTAL UNITS

FOR AMATEURS

For your  
TRANSMITTER

HIGHER  
ACCURACY

COMPETITIVE  
PRICES

Delivery  
FROM STOCK

For your  
FREQUENCY STANDARD

**SALFORD ELECTRICAL INSTRUMENTS LTD.**

PEEL WORKS, SALFORD 3

Proprietors: THE GENERAL ELECTRIC Co. Ltd., of England

**G. A. RYALL**, 65, Nightingale Lane, London, S.W.12. Mail order only. No c.o.d. under £1 please. Postages extra on all orders. Please write plainly. All new goods, unused. U.S.A. make 0.1mf 500v tubular screened condensers, 5/6 dozen; resistances, assorted, 1/4w, 1/2w, 1w, best makes, sizes from 100 ohms to 2 meg, including fifteen half-watt sizes, 40 for 5/-, our assortment only; also 2 watt 150,000, 220,000, 470,000, 820,000, 43,000, 3/- dozen; 33,000 ohm 3 watt, 3/- dozen; 1,800 wire wound, 1/- dozen; panels with screened 0.1mf and 12 1/4w resistances, 2/3 each; Yaxley type switches, 9-way, single bank 2/3, and double bank 3P, 3w 2/3; three bank 2P, 4w, with middle screen, special type, 3/9, post 8d.

**OCIAL** panels with metal caps and chassis type sockets, 2/6, with solder tags 3/- each. U.S.A. 4-, 6-pin chassis valve holders, 3/- dozen to clear; vitreous resistances, 20w, 4,700 ohms, with clips, 2/-; 1,000 ohms less clips, 1/6; 500 ohms with clips, 1/6; wire wound heavy duty L.T. droppers, eight ohms, on porcelain formers, standard length, two taps, adjustable, 2/3; sliding resistances on stand, worm drive, 25 amps, 0.4 ohms, 7/6 each.

**CONTROL** boxes, metal, with Yaxley type 2-bank, 4w 2p switch with 2 1/2in well finished potentiometer knob, and on/off toggle, and DP DT toggle, size case 6x3x3 approx., 5/- each; small type with fixing bracket containing toggle switch wired as SP DT section wound 25 ohm HF choke, 0.0005 mica condenser, 800 ohm resistance, size 3x2x1 1/2in approx., 1/9; control box type A.M.404 with Yaxley type switch, 5w 2P 3B, well finished knob, internal toggle switch, three green indication lamp holders, 2/6, with panel fixing, 3/- each. Metal type bulb, push switch, double M. & B. relay of 20,000 ohms, 1B 2M ceramic and spaced insulation; second relay of 3,000 ohms single pole M. & B., case size 10x4x3 1/2 approx., 12/6 each; control box type A.M. 5c/430, with Yaxley type 2b 3p 3w with small knob, red indication lampholder with bulb, resistance panel with 0.1mf 500v 280 ohm 2 watt, 40 ohm 1 watt, etc., 10-way size 5x3, and two 25mf 50v electrolytics two-way plug and jack, ditto single one large plug, 4-way type 10H/735, full two yards twin screened cable, full six yards twin rubber cable, Paxolin anchor block, 3-way, for cable, 2-way inspection block, in flat metal case 8x6x2 approx., 10/6 each, perfect condition; Paxolin panels, quarter inch, 12x12 7/6, 12x8 5/9, 8x8 3/9; metal boxes, ideal for instrument cases, etc., with quarter inch Paxolin panels, size 8 1/2x7 1/2x3 1/2 deep approx., four fixing lugs, four corner sockets for panel fixing, 6/9 each. Complete battery type amplifiers, 2v, contain four input, intervalve and output transformers, for microphone amplification, complete with triode coupled to QP21 type valve, slightly soiled, not guaranteed, 25/- each, in metal cases; R.F. amplifiers, type 25, ex-R.A.F., new in cartons, contain 5w 5P, 3B ceramic switch, 15 R.F. type transformers, in three divisions, three SP41 metalised valves in ampulon valve holders. Ceramic coils easily detachable for rewinding, fixed tuning, complete in metal case, with res. and cond., with good switch knob, 50/- each; heavy duty starters in bakelite cases, 5/-; new high resistance phones with low resistance mike, boxed, with sponge earpads, plug type 10H1/0991 4-way, 10/9 set; ditto, second-hand, not guaranteed, 5/6; the G.P.O. type mikes in phones and mike are easily detachable for separate use; test gags with bulldog clip, 2/6; high speed on/off relays, 1,000 ohms, 5/-; relays, small, 300 ohm on/off, about 20ma, ceramic, 3/6; volume controls, 10,000 ohm, medium spindle, 1/6; short spindle, 1/4 meg and 1 meg, 1/6. [7369]

**EX-GOVERNMENT** stock—7,500 transmit- ters, oscillators, power units, receivers, rotary converters, three SP41 slow motion dials, 12-24 motors, amp. and voltmeters, at fraction of original cost; callers only.—Alec Davis, 8, Percy St., W.1. [7225]

**FEEDER** units incorporating Denco C.T.2 coil turrets, Denco High "Q" I.F.T.s (Q.155) wired and aligned, E.C.H.35, 5/- each. E.B.C.33 or 6K.8. 6S.8K.7 and 6R.7: usual guarantee; superlative performance; 6 1/2in square; price £9/9.

1947 H.F. amplifiers using valve stabilised power pack, continuously variable treble and base controls, P.X.25 output using feed back; sold separately or complete with 6-band feeder; details upon application.

**DENCO** Q-Max and Armstrong stockists.—Godsell Ltd., 40, Gardner St., Brighton.

I.F. transformer replacement bobbins (uses original can and trimmers), 6/- each. r.f. chokes, superhet type, 2/-; sectionalised wave-coils, 3/-; type X coils, 1 1/2in x 1/2in dia., all ranges, 3/-; 3-band coil assemblies, 6/9 each.—Electronic Services, Arwenack St., Fal-mouth. [7116]

# GALPINS

**ELECTRICAL STORES**  
408, HIGH ST., LEWISHAM, LONDON, S.E.13. Telephone: Lee Green 0309. Near Lewisham Hospital.

**TERMS:** Cash with order. Regret no C.O.D.

**ELECTRIC LIGHT CHECK METERS,** K.W.H. type, for A.C. only, 200/250 volts 50 cycle, 1 phase, 5 amp. load, 12/6 each; 10 amp. 15/-; 15 amp. 20/-; 20 amp. 25/-; 30 amp. 30/-; 50 amp. 40/-; 100 amp. 50/-; Carriage 1/6 extra on each, all guaranteed.

**EX-G.P.O. PRE-UNISELECTORS,** 3 ohm automatic relay operating a 4-way Yaxley switch, fitted with 2 condensers, 0.1, 1 1/2 M.F., new, boxed, 5/- each. G.P.O. Polarised Telegraph Sounders in new condition, 10/- each. G.P.O. Polarised Relays, operating on 10/20 m.c./amps coil resistance, 230 ohms, 10/- each, as new.

**SHUNT WOUND D.C.** 110 volt motors, 1,500 r.p.m., approx. 1/2 h.p., condition as new, 17/6 each, post 2/-.

**EVERETT EDGUMBE 2in. METERS,** 0 to 5 volts A.C./D.C., incorporating Westing-house Rectifier, 47/6. Ditto, calibrated in decibels +3-10, with rectifier, 65/-. Another reading 15-0-15 m.amps., 35/-. Ditto, 30-0-30 m.amps., 35/-. These meters are all first grade moving coil instruments.

**EX-G.P.O. VERTICAL TYPE GALVANO-METERS,** current zero reading 30/0/30, 7/6 each, post 1/-; Mallory 12 volt vibrators, new and unused, 7/6 each. Electrolytic condensers, 80 mf. 350 volt wkg., 5/6 each, post 9d.

**WESTON MOVING COIL METERS,** edge type with knife edge pointers, 2 1/2in. scale, all 2 m.a. F.S.D., 0 to 300 m.a., 30/-; 0 to 2 amps., 27/6; 0 to 60 volts, 27/6; 0 to 150 volts, 27/6; ditto, 0 to 1 volt 1 m.a., 1,000 ohm per volt, 35/-; another 301 model 0 to 3 m.a., 35/-; 0 to 50 m.a., 30/-; 0 to 200 m.a., 32/6; another 501 model 0 to 50 m.a., 27/6; 0 to 10 m.a., 27/6.

**SMALL ELECTRIC MOTORS** for A.C. or D.C., 80/100 volts, useful for sewing machines, Pathe Cine's, etc., double ended shaft, 30/- each.

**VOLTAGE CHANGER TRANSFORMERS,** auto wound, fully guaranteed, immediate delivery, all tapper 0, 110, 200, 220, 240 volts, 250 watts, 45/-; 350 watts, 55/-; 500 watts, 70/-; 1,000 watts, £5/10/-; 2,000 watts, £8/15/0.

**EX-GOVT. ROTARY CONVERTERS,** input 12 to 18 volts D.C. at 3i amps., output 450 volts 60 m.amps., fitted with automatic switching and smoothing, 32/6 each, 2/6 carriage. Also a few only to clear, as above, but without brushes or brush caps, at 28/- each, post 2/6.

**EX-G.P.O. Permanent Magnet Moving Coil Speakers** (makers Tannoy), suitable for extension or small P.A. work, fitted in wooden case, 9 x 9 x 7in., as new, 27/6 each, post 1/6.

**EX-R.A.F. OSCILLATORS,** complete as new, with valves, 4 neon balancer, 2 barretters and 1 output VT.60A, complete in case, 16 x 13 1/2 x 8 1/2in., price 75/6 each, carr. paid.

**MAINS TRANSFORMERS** by well-known makers. Input 200/250 volts, output 450/0/450 volts at 150 m.a., 6 v. 2 amps, 5v. 2 amps., 37/6 each, post 2/-; another, 230 volts input, 110 volts output at 4 kilowatts, £17/10/0, carr. forward.

**EX-R.A.F. CATHODE RAY RECTIFIER UNITS,** comprising of Transformers, High Voltage Condensers, Tube Holder, approx. 100 Condensers and Resistances, all mounted on base board 23 x 11 1/2in., enclosed in metal case. Weight 90lbs., price 65/-, carriage 5/-.

**MAINS TRANSFORMERS** by well-known makers, 80 volts input, 420/0/420 v. at 250 m.a., 6.3 v. 6 a., 5 v. 2 a., 4 v. 3 a., 15/- each. Another, 200/250 volts input, 350/0/350 v. at 200 m.a., 6.3 v. 20 amps., 5 v. 3 amps., weight 16 lbs., 45/-, carriage 2/6.

**EX-G.P.O. (U.S.A.) CONVERTORS, VIBRATOR** type, 3/6 volts D.C. input, 100/120 volts A.C. output, enclosed in metal carrying case 7 x 6 1/2 x 5 1/2in. New and unused, 25/- each, carriage 2/-.

**VARIAC BALANCER TRANSFORMERS,** 1-6 k.w., 220, 200/260 volts 50 cycle, 1 phase, as new, 85/- each.

**FERRANTI MOVING COIL** 0 to 40 v/meters, 2in. scale, 5 m.a. F.S.D., new and unused, 22/6 each; another 0 to 1 m.a., 2in. scale. Makers: Victoria Insts., 25/- each.

**HEAVY DUTY CHOKES, WOUND** with copper strip, make good 500 watt rewinds, new and unused, 17/6, post 2/-.

**SLEEVING**—A large quantity of new sleeving for disposal—silk and cotton covered P.V.C., varnished cotton, Idaglass, synthetic rubber etc., in coils of 14yds and 1yd lengths, 1mm to 10mm diameter.—John Walton & Co. (Castleside), Ltd., Metalex Works, Gt. Cambridge Rd., Enfield, 16916

**WAVE** change switches.—We have surplus to our requirements, 1,000 wavechange switches, single and 2-pole per wafer, 4 position; these switches can be made up to your own requirements, i.e., number of wafers, distance between wafers, etc.—Enquiries to Twin Radio & Television, Ltd., 28, Newton Rd., Kingsleywell, Newton Abbot, Devon, 17239

**K 5-valve**, new materials, table models, semi-midget; our latest kit—Wylwyn Star 1947 has connections for gramophone pick-up, extensions to loudspeaker A.V.C., 6 hours average time for constructing; full details, diagrams with each kit; c.w.o. or c.o.d.—Isherwoods, Reme House, 81, Plungington Rd., Preston, Tel. 3548. Estd. 1936. [6788]

**EX-R.A.F.** Identification Friend or Foe receiving and transmitting units with 4 straight mains H.P. pentodes, Mazda, one Mullard E.F.50, 3 television diodes and 2 double-triode mains valves by Brimar; also 20 watts motor generator, 24 volt input, 480 volt 40 m.a. output, 50/- each, plus carriage 4/-; includes a wealth of small components such as carbon and w.w. resistors, tubular and mica condensers, all good values, plus coils and condensers, magnetic relays and mechanical relays.—W. Harford, 128, Greengate, Bedford, 3. [7060]

**SELECT RADIO 151,** Ley St., Ilford, Essex. Tel. 111 2685.—The right goods at the right price: 3 linecord, 60-700 per ft., 19/- doz yards; 3 mains droppers, heavy duty, 4/6 each; Mazda octal valve holders, 3/6 per doz; 8mkl 500V wire ends condensers, 36/- doz; 8+8mkl 500V metal can, 5/3 each; 5 waveband coil packs, 36/6 each; midget I.F.S. 465 kc, 19/6 per pair; 8in Merco p.m. speakers, 20/- each; all valves at B.o.T. prices; send s.a.e. for current list; cash with order; no c.o.d.; add extra 4/- orders under £5 for post and packing. [7339]

## MISCELLANEOUS

**RADIO** hams! S.E. district.

**E. A. PORRITT** can supply most of your requirements, no order too small or too large, every caller is offered our best; information on all amateur subjects gladly given; Denco products stockist.—Call or write, E. A. Porritt, 13 & 27, Wastdale Rd., Forest Hill, S.E.23.

**COMPLETE** radio P.T.I. repeater, using 12 tubes & C.T. tubes offers—Box 7606.

**LAMINATION** strip, 6in x 1/2in x 0.005in, 1 1/2 tons.—John Downton & Co., 89, High St., Epping, Tel. 2163. [7321]

**TIME** recorders.—Write for particulars.

Gledhill Brook Time Recorders, Ltd., 84 Empire Works, Huddersfield, Tel. 49

**IR** stock—Send cores—Several patterns in large quantities available; samples.—John Downton & Co., 89, High St., Epping, Tel. 2163. [7165]

**COMPLETE** wireless station, ideal Field Day outfit; price and details on request.—J. Bull (Ruissil), Ltd., 42-46, Windmill Hill, Ruissil, Middlesex. [7203]

**CLASSIS** and panels in aluminium, from 3/9 each, prompt delivery, any size plain or punched for valveholders, etc.—E. A. D., 13, Bence Lane, Darton, Barnsley. [7209]

**CIRCUIT** diagrams (individual designs) to order; chassis assembled or adjusted by oscillograph; drawings prepared, advice given of elect., mech. or radio-electronics.—Write to R. G. Young, 3a, Bridges Rd., Wimbledon.

**PERISPEX** stockists have for sale wide range of colours and thicknesses for dials and all purposes, cut to any size and shape. PerispeX cement and polishes.—S.a.e. for stock list to C. B. & S., 47, Stoney Lane, Birmingham, 12.

**GENUINE** R.A.F. new precision pocket watches (15 ruby jewels), accurate time-keepers, bargain offer, £6/10. Government price £8/10; Decca PT/AC 5-valve 3-band press-button Superhets, pre-war, beautiful cabinets, 12/6s (worth double); all free of purchase tax.—Collins' Depot, 9-11, Riverside Rd., Newton, Warwickshire, Tel. 3076. [7227]

**WANTED, EXCHANGE, ETC.**

**SERVICE** sheets, pref "Trader," all numbers.—Box 7439. [7235]

**WANTED,** good condition, "W.W." August 17th and 31st, 1939.—Box 7435. [7224]

**MAGNAVOX** "66" and "55" speakers.—Crouch, 11, Dingle Close, Bristol, 9.

**WANTED,** Varley permeability tamer B.P.10; state cond., price.—Box 7808.

**WTD,** Olympic 88 for components.—Wardell 63, Risbygate St., Bury St. Edmunds.

**URG.** reqd., UY1, UY12 radio valve.—I. Kinsella, "Cintra," Park Rd., Hale, Ches.

# DALY ELECTROLYTICS

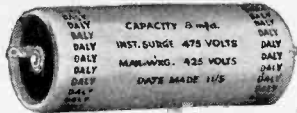

Tube—size 2 1/2" x 1"



Can—size 4 1/2" x 1 1/2"



Block—size 4 1/2" x 1 1/2"

The DALY range covers all requirements

Note—All Condensers bear the date made

## DALY (CONDENSERS) LTD

Condenser Specialists for over 20 years

West Lodge Works, The Green, Ealing, W5

'Phone—Ealing 4841

## "ENGINEERING OPPORTUNITIES"



This unique handbook shows the easy way to secure A.M.I.Mech.E., A.M.Brit.I.R.E., A.M.I.E.E., City and Guilds, etc.

**WE GUARANTEE— "NO PASS—NO FEE."**

Details are given of over 150 Diploma courses in all branches of Civil, Mech., Elec., Motor, Aero., Radio, Television and Production Engineering, Tracing, Building, Govt. Employment, R.A.F. Maths., Matriculation, etc.

Safeguard your future; send for your copy at once—FREE.

B.I.E.T., 387, SHAKESPEARE HOUSE, 17, STRATFORD PLACE, LONDON, W.1.

## THE AURI-PHONE

A miniature Ear-  
phone with a high-  
fidelity reproduction  
of Speech and  
Music equal to best  
headphones known.  
1 1/16 inch diam.;  
weight 1/2 oz.; holds in  
Ear without headband  
or wire loop. Two  
interchangeable  
nipples, large and  
small; two models, 10 ohms, and 1,000 ohms.  
Operate from prim. or sec. terminals of  
Speaker transformer, ideal for pocket radio,  
Valve or Crystal set. 5ft. flex cord. Price,  
black or flesh-colour enamel, 39/-. Reg. Post  
free. **NOTE:** We do not make Deaf Aids.

Pat. pend.  
10525/45



**CEFA INSTRUMENTS**, 38a, York Street,  
TWICKENHAM, Middx. POPesgrove 6597.

WTD, frequency record, H.M.V., hypersensitive p.u. with trans, ac. oscil.—Box 7427.  
**F**ERROCAT coils, G123M.S., band-pass Colvern.—Waterman, 41, Ingleton Rd., N.18.  
**W**ANTED, electric gramophone turntable, non-auto.—9, Kimberley Gardens, New-castle-on-Tyne. [7311]

**M**IDWEST New Imperial 15-valve wanted, contact with an owner or anyone having data on this receiver.—Box 7750. [7318]  
**W**TD, for cash (Canadian) R103 Mk 1 or similar battery sets, covering 1,520 to 2,225 Kc/s.—Matheson, Fishmarket, Aberdeen.  
**W**ANTED, copies "Wireless Engineer," April, 1943, June, July, Dec., Dec., 1941, and Index Abstracts 1942.—Brown, 37, The Chesils, Coventry. [7228]

**W**ANTED, surplus transformers, new or damaged.—Send sample and price to: Sea Rescue Equipment, Ltd., Children Works, Watford. [7266]  
**G**W. SMITH & Co (RADIO), Ltd., require the following: new or second-hand radio receivers and radiograms; all classes of radio test equipment; highest cash prices paid.  
**G**W. SMITH & Co. (RADIO), Ltd., 2, Ceefl Rd., Southgate, London, N.14. Tel. Enterprise 5463. [5116]

**W**E need for radio production 2 gauge condensers, mains transformers, electrolytics, loud speakers, valves and all kinds of other components; please let us have your offers without delay.—Write Box 6856. [7103]  
**.0005** mid bakelite dielectric tuning condensers, also permanent crystal detectors required in large or small quantities; quotations to Television & Radio (Rebuilders), Ltd., 142, West End Lane, N.W.6. [7282]

**W**E buy for cash, new, used, radio, electrical equipment, all types; especially wanted, radios, radiograms, test equipment, motors, chargers, recording gear, etc.—If you want to sell at the maximum price, call, write or phone to University Radio, Ltd., 22, Lisle St., Leicester Sq., W.C.2, Ger. 4447.

### REPAIRS AND SERVICE

**M**AINS transformer, rewound and constructed to any specification; prompt delivery.—Brown, 3, Bede Burn Rd., Jarrow, 3460  
**L**OUDSPEAKER repairs, British, American, any make; moderate prices.—Sinclair Speakers, 12, Pembroke St., London, N.1. Terminus 4355. [3308]

**E**LECTRICAL measuring instruments skillfully repaired and recalibrated.—Electrical Instrument Repair Service, 329, Kilburn Lane, London, W.9. Tel. Lad. 4168. [6935]

**R**EWINDS and conversions to mains and output transformers, fields, etc., from 4/6; pp equipment a speciality.—N.L. Rewinds, 4, Brecknock Rd., N.7. Tel. Arnold 3390. [6283]

**R**EPAIRS to moving coil speakers, cones, coils fitted, field rewound or altered; speaker transformers, clock coils rewound, guaranteed satisfaction, prompt service; no mains trans. accepted.  
**L.S. REPAIR SERVICE**, 49, Trinity Rd., Upper Tooting, London, S.W.17. [4819]

**C**OIL specialists.—Tuning and oscillator coils, i.f. and i.t. transformers, chokes, etc., rewound and wound to specification.—Electronic Services (R.T.R.A. Service Section), Arwenack St., Falmouth. [7117]

**S**TURDY rewinds, mains transformers, S chokes and fields; we give prompt delivery and guarantee satisfaction; 14 years' experience; prices on request.—Sturdy Electric Co., Ltd., Dipton, Newcastle-on-Tyne. [4336]

**L**OUDSPEAKER repairs, any make, reasonable prices, prompt delivery, to the trade and quality fans, 25 years' combined experience with Rola, Magnavox, Goodmans, Ceston.—Sound Service Radio, 80, Richmond Rd., Kingston-on-Thames, Kin. 8008. [4977]

**R**EWINDS, mains transformers layer wound wax impregnated, O/P transformers, chokes, fields, clock coils, pick-ups, fractional hp motors, competitive prices, prompt delivery; guaranteed work.—W. Groves, Manufacturing Electrical Engineer, 154, Icknield Port Rd., Birmingham, 16. [4547]

**A**LL makes and kinds of electrical and radio measuring instruments repaired by skilled technicians, A.I.D. approved; all work quoted by return without charge. Also for sale, large variety of voltmeters, ammeters, milli-ammeters, 2in and 2 1/2in dial, reconditioned ex-Air Ministry stock.—W. O. Prescott, Ltd., Dept. D., 29-31, Cowcross St., E.C.1. Tel. Cde. 6783. [6205]

**N**ATIONAL RADIO SERVICE & TELEVISION CO.—Trade service engineers; immediate service any district; rewinds to all types transformers, armatures, motors, loud-speaker cones, speech coils fitted; British and American components and valves; enquiries invited for contract trade service; multiple transformer winding—53, High St., St. John's Wood, N.W.8. Primrose 6725. [6752]

## RADIO CORNER

(Proprietor, T. R. WILLIAMS)

138 GRAY'S INN RD., LONDON, W.C.1

Terminus 7937

**MAIL ORDER.** Delivery by return. **THE BANNER CHARGER.** Type 1/1, 1 amp, ideal for Motorists, a really first-class job. Input 240 v A.C. Output 2, 6 or 12 v D.C., at £3. Designed for the motorist who likes to keep his batteries in tip-top condition.

**RADIO VALVE MANUAL**, giving American and British Valve Equivalents and Data. Price 3/6  
**Radio Constructors Manual.** Price 3/-  
**Radio Tuner Unit Manual.** Price 2/6  
**Engineers and Electricians Handbook.** Price 1/-  
**Cathode Ray Oscilloscope Manual.** Price 2/-  
**Radio Reference Book.** Price 12/6.

**American Radio Valves.** Types as under at controlled prices. 4Z5GT, 5Y3G, 1A5GT, 1C5GT, 1T5GT, 80G, 3Z5Z, at 11/- each. 6Q7GT, 12J5GT, 1H5GT, 12SF5GT, at 9/2 each. 6Q7GT, 12Q7GT, 12SQ7GT, at 11/7 each. 12SK7GT, 6K7GT, 6K6GT, 6V6GT, 42G, 43G, at 12/10 each. 6AB8T, 6K8GT, at 14/- each. Postage paid. Other types as they become available for distribution.

## AMERICAN RADIO SERVICE MANUALS

- Volume I. Spartan Emerson.
- II. Crosley Belmont. Part I.
- III. Crosley Belmont. Part II.
- V. Emerson. Part II.
- VI. Stewart Warren FADA.

At 12/6 per Volume, or complete set of six manuals £3 12s. 6d. These Manuals cover the complete range of American Radio Receivers as given and are invaluable and contain all the technical data necessary.

**Terms.** Cash with Order only. We regret that we are unable to send goods C.O.D.

## COVENTRY RADIO

COMPONENT SPECIALISTS SINCE 1925.

HAVE YOU RECEIVED OUR  
**1947 LIST**  
OF RADIO COMPONENTS?  
THE MOST COMPREHENSIVE LIST  
AVAILABLE TODAY.

**PRICE 3d. POST PAID**  
**COVENTRY RADIO,**  
DUNSTABLE ROAD, LUTON, BEDS.

## WARD ROTARY CONVERTERS

For Radio, Neon Signs, Television, Fluorescent Lighting, X-ray, Cinema Equipment and innumerable other applications

We manufacture:—  
**Petrol Electric Generating Plants, H.T. Generators, D.C. Motors, etc., up to 25 K.V.A.**

**CHAS. F. WARD**  
Lordscroft Works, HAVERHILL, SUFFOLK.  
Telephone: Haverhill 201.



# 'Astronic'

TRADE MARK

BNN Series, single, dual or tri-alloy screened Transformers. Hermetically sealed with soldering spills or with tag panel, both for sub-chassis wiring or with international octal base.



#### APPLICATION :

Line to grid, line to line, microphone, driver, intervalve, anode to line, etc.

#### HERMETIC SEALING :

In view of the increasing demand for hermetically sealed versions of the BNN series, an integral glass sealed base has been developed.

Literature, in course of preparation, on request.

**ASSOCIATED  
ELECTRONIC ENGINEERS Ltd.**  
DALSTON GDNS. · STANMORE · MIDPX.  
Wordsworth 4474-5-6.

e.h.vv.vv.

## TRANSFORMERS & CHOKES

To Special requirements 14 days

High Quality Vacuum Impregnated

**AUSTIN MILLS LTD.**

LOWER CARRS

STOCKPORT

Telephone : STO. 3791 Established 20 years.

## SERVICEMEN.

### Three New Publications For You :-

**M.C.R.I.**—Wiring diagrams, practical layouts, and useful information on the servicing of the Midget Communication Receiver M.C.R.I. Post free 2/9.

**"Demobbee Valves."**—A 15-page manuscript which is divided into four sections. Section 1 classifies Service Valves and gives their commercial equivalents; Section 2 classifies Civilian valves and gives their service equivalents; Sections 3 and 4 deal similarly with American valves. A most useful manuscript now that there are so many ex-government valves about. Post free 2/6.

**"I.F. Alignment Peaks,"** compiled and edited by T. E. Fevyer, F.I.P.R.E., lists more than 4,500 I.F. alignment frequencies or "peaks" for superheterodyne receivers used in this country. Some forty-odd pages of double column figures, enable the engineer to find quickly the correct alignment frequency of virtually every superheterodyne set on the market whether out of date or up to date. An indispensable reference manual and time-saver. Metric conversion tables of the "peaking" frequencies and suggestions for finding an unknown or unlisted intermediate frequency are appended as essential data for the engineer. Post free 7/6.

V.E.S., 42-46, WINDMILL HILL, RUISLIP, MIDDLESEX.

CONTACT sought with specialist able to advise occasionally on R.F. transmission line problems.—Box 7442. [7241]

**REQUIRED** by instrument company engaged on industrial telecommunications and medical measuring equipment.

(A) **ONE Development Engineer;** good physics degree or equivalent and some years' experience in comparable work; age at least 25 years; salary according to experience.

(B) **ONE Mechanical Designer;** radio experience and degree or equivalent essential; salary £430-£590 p.a.

(C) **ONE Technical Assistant;** radio experience essential, salary £6 per week upwards according to experience.—Box 6857. [7104]

**EXPERIENCED** radio television engineer required, able to drive; write, giving details of experience and salary required, S.W. London area.—Box 7747. [7308]

**FOREMAN,** experienced in component manufacture and assembly of radio valves for factory in Home Counties.—Write full details, age, experience and salary required, to Box 7605. [7273]

**DRAUGHTSMAN,** junior, under 20, either sex, radio and electrical technical drawing for reproduction; perspective drawing an asset; good prospects; C. London; age, experience, salary.—Box 7433. [7218]

**EXPERIENCED** buyer required by progressive radio factory, in North London area, sound knowledge of trade essential; apply fully stating age, qualifications, experience and salary required.—Box 7741. [7293]

**REQUIRED** for small radio factory, a really first class technician, who is also capable of controlling staff for the increased development of radio receivers and sound equipment.—Reply in writing to Box 7440. [7237]

**RADIO** component manufacturers in the Midlands require assistant foreman in their Bakelite Assembly Department; good salary and production bonus offered; applications should give full particulars of exp.—Box 7806.

**LABORATORY** engineers are required for development work on broadcast receivers, the laboratory is South-West of London, 30 minutes from Waterloo; please write, stating age, salary expected, experience and qualifications.—Box 7437. [7232]

**DESIGNER** draughtsman required by Philips Laboratories, experienced in communications equipment (electrical and mechanical)—Apply in writing, giving full particulars, to Philips Transmission, Ltd., Brathway Rd., London. S.W.18. [6909]

**THE** Home Office invites applications from men under 42 with experience of very high frequency wireless for the post of senior wireless engineer in its Communications Directorate. Salary £650-£750, plus consolidation addition of £90.

**CANDIDATES** should possess professional qualifications in electrical engineering or equivalent experience. Application forms and fuller details of the Service may be obtained from the Establishment Officer (Room 307), Home Office, Whitehall, S.W.1. Completed application forms must be returned to the Home Office not later than 31st May, 1947.

**DEVELOPMENT** engineers wanted for design of radio test equipment, previous experience in similar work essential.—Write, giving full particulars of experience and salary required, to Taylor Electrical Instruments, Ltd., 419-424, Montrose Avenue, Slough, Bucks. [7280]

**RADIO** valve manufacturer is seeking technical and production staff of various grades, previous experience an advantage but not essential; vacancies now in London factories, but opportunities later in new provincial undertaking.—Reply to Box 7434. [7222]

**ELECTRICAL** engineers, over 20, for West London; applicants should have a sound technical training and experience in L.F. amplification for testing, installation and service work.—Reply giving details of age, qualifications, experience and salary required, to 7535. [7271]

**PHYSICISTS** and electrical engineers required for work on Radar and radio navigational equipment; experience in radio research or development is essential, an honours degree desirable; several vacancies exist within the salary range £400-£900, dependent on qualifications and experience.—Application forms are obtainable from the Personnel Manager, Ferranti, Ltd., Ferry Rd., Edinburgh, 5. [7341]

**CHIEF** engineer required for company manufacturing radio test equipment, to take full charge of design of new equipment; also responsible for testing departments and quality control.—Apply, giving age, experience, technical qualifications and salary required, to Box 6855. [7102]

## Long Term

### DEPENDABILITY

## "LOWTHER-VOIGT"

### REALISTIC REPRODUCTION

### DEMONSTRATIONS DAILY

AT

THE

## LOWTHER MANUFACTURING CO.,

LOWTHER HSE., ST. MARK'S RD.,

BROMLEY, KENT.

RAVENSBORNE 5225

Radiographic can now offer the following  
**Transmitting VALVES :**

EIMAC 35T.. 45/- RCA 813.. 110/-

RCA 805 .. 110/- RCA 866.. 27/6

Send for Lists of TX VALVES.

100TH Available Shortly.

## RADIOGRAPHIC LTD.

66, OSBORNE ST., GLASGOW

## "VIBRO-ARC" Engraving Pen

15/-



For rapid engraving any metal—hard or soft.  
Operates from 4-6v Battery or A.C. Transformer giving 6-10 amps.

**HOLBOROW & CO.,**

8, Mossley Avenue, Wallisdown, Bournemouth.

100 kcs.  
**QUARTZ  
CRYSTAL  
UNIT**  
Type  
Q5/100



for Secondary Frequency Standards

★ Accuracy better than 0.01%. ★ New angles of cut give a temperature coefficient of 2 parts in a million per degree Centigrade temperature change. ★ Vitreous silver electrodes fired direct on to the faces of the crystal itself, giving permanence of calibration. ★ Simple single valve circuit gives strong harmonics at 100 kcs. to 20,000 kcs. ★ Octal based mount of compact dimensions.  
PRICE 45/- Post Free

Full details of the Q5/100, including circuit, are contained in our leaflet Q1. Send stamp to-day for your copy.

**THE QUARTZ CRYSTAL Co., Ltd.**

63-71 Kingston Road,

NEW MALDEN, SURREY

Telephone : MALden 0334

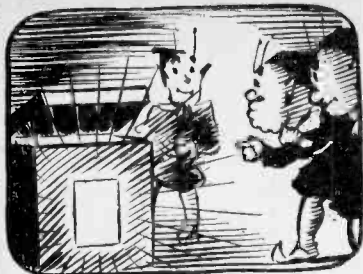

THE "FLUXITE QUINS" AT WORK

"Hey quick! Look, our set's all alight!  
We've got a big fuse there all right."  
"Don't worry," EE cried,  
"That's our lad gone inside  
With a torch and at in of FLUXITE!"

See that FLUXITE is always by you—in the house—garage—workshop — wherever speedy soldering is needed. Used for over 30 years in Government works and by leading engineers and manufacturers. Of all Iron-mongers—in tins, 10d., 1/6 & 3/-.

TO CYCLISTS! Your wheels will NOT keep round and true unless the spokes are tied with fine wire at the crossings AND SOLDERED. This makes a much stronger wheel. It's simple—with FLUXITE—but IMPORTANT.

The FLUXITE GUN puts FLUXITE where you want it by a simple pressure. Price 1/6, or filled, 2/6.



ALL MECHANICS WILL HAVE

# FLUXITE

IT SIMPLIFIES ALL SOLDERING

Write for Book on the ART OF "SOFT" SOLDERING and for Leaflets on CASE-HARDENING STEEL and TEMPERING TOOLS with FLUXITE. Price 1d. each.

FLUXITE LTD.

(Dept. W.W.), Bermondsey Street, S.E.1

ASSISTANT required in electronic laboratory of a large industrial concern in North-West London; applicants should have had experience with electro-magnetic devices, motors, etc., as well as with Electronit circuits, and should state experience and salary required.—Box 7436. [7230]

ELECTRONIC development engineer required for electro-medical and similar apparatus. degree or equivalent; salary £400-£500 according to qualifications and experience.—Write for application form, Ref. D.E. to Personnel Manager, The Edison Swan Electric Co., Ltd., Ponders End, Middlesex. [7220]

DRAUGHTSMEN and tracers required with exp. in prod. of working drawings from data supplied by designer; (1) mech. draughting (2) elect., preferably with exp. on radio comm. equipment; workshop exp. preferred.—Apply, in writing, giving full details, to Philips Transmission, Ltd., Brathway Rd., S.W.18.

REQUIRED first class designer draughtsman with experience of radio and electrical equipment and the design of chassis, press tools, sub-assemblies, etc.; mechanical knowledge desirable radio and electrical engineers in London area.—Write, stating age, experience and salary required, to Box 7532. [7264]

RADAR and radio senior assembly foremen. At least three are required for assembly of radar and radio equipments, Manchester area; this is a golden opportunity for men of the right calibre, and initiative.—Apply, giving full particulars of age, experience, qualifications and salary required, to Box 7448. [7258]

DESIGNER draughtsman required by old established firm near Croydon, experienced in design and development of light electro-mechanical apparatus; knowledge of workshop practice and production problems; capable of working on own initiative; salary £442 p.a.—Apply, stating age, qualifications etc., to Box 7445. [7248]

RADIO engineering company in South London requires engineer to take charge of test department specializing in radio navigational equipment; applicants must be able to prove they have first class technical qualifications combined with considerable experience in similar work; position offers good opportunities to the right man.—Write full details to Box 7429. [7202]

RADAR and radio machine shop foremen. At least three senior machine shop foremen are required to supervise the production of components for radar and radio equipments, Manchester area; this is a golden opportunity for men of the right calibre, and initiative.—Apply, giving full particulars of age, experience, qualifications and salary required, to Box 7447. [7257]

MASTER wanted for leading radio college in London; correspondence, lecture and practical courses, science degree (or equivalent) and good practical outlook essential, age preferably not over 30; salary £350-£500 according to age, qualifications and experience, cost of living allowance 29/6 per week, and superannuation benefits.—Apply, stating age, fullest details of education and experience, to Box 7432. [7216]

TECHNICAL assistant required to act as secretary to committees covering a wide range of technical subjects; a knowledge of telecommunication technique desirable; salary £500 to £700, according to qualifications and experience.—Applications to be made in writing to the Director, British Standards Institution, 28, Victoria St., London, S.W.1, the envelope being marked "Technical Assistant."

THE Home Office invites applications from men between 21 and 51 with experience of very high frequency wireless for the following permanent and pensionable posts in its Regional Wireless Service: Regional wireless engineer, salary £620-£710; Chief wireless technician, salary not less than £420 at age 30—£570; Senior wireless technician, salary £375-£475; Wireless technician, salary £280 (at 25)—£370.

CANDIDATES should apply for application forms and fuller details of the Service to the Establishment Officer, Room 307, Home Office, Whitehall, S.W.1, or to the Chief Officer, Civil Service Commission, at the following addresses:—

(INDIA) 10 Underhill Lane, Delhi.  
(EGYPT) 8 Sharia Tolubat, Garden City, Cairo.  
(GERMANY) c/o 2nd Echelon, G.H.Q., B.A.O.R.

COMPLETED application forms must be returned to the Home Office not later than 31st May, 1947, for candidates in the United Kingdom and by 31st July, 1947, for candidates overseas. [7256]

1331

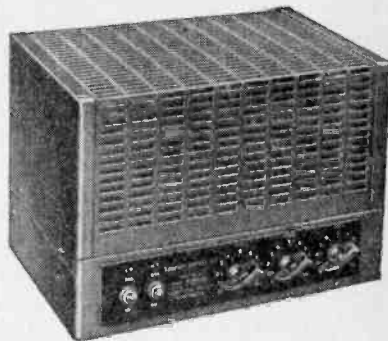

## DESIGN FOR P.A.

The MB.31 amplifier incorporates the Cathode-anode output circuit developed by Acoustical, resulting in a total distortion content incapable of detection by the human ear. A flat frequency response from 40 — 15,000 c.p.s. is obtainable, modified by a microphone volume control so weighted that "natural" reproduction is maintained at all levels.

Introducing compression near full output, a higher average output level can be handled without the distress caused by overload peaks. Operating from AC mains or 12-volt battery, and having alternative input and output impedances, the MB.31 amplifier is extremely versatile and suitable for most types of general public address work.



## ACOUSTICAL

ACOUSTICAL MANUFACTURING CO. LTD.  
HUNTINGDON. Tel.361

## AMATEUR CRYSTALS IN MINIATURE

.02% calibration accuracy. 2 in 1 million 1% temperature coefficient.

7 megacycles..... 27/6 each.  
14 megacycles..... 35/- each.  
Hermetically sealed in glass button based envelope standard B7G base.

(Small stocks at present, but delivery improving).

### AMERICAN VALVES (NEW)

Button Base, Acorn, Metal and G.T. Types. Available from Stock.

9001, 9002, 9003, 15/- ea. GAG5, 6AK5, 6C4, 6J6, 15/- ea. 955, 25/- ea. 957, 35/- ea. 024, 15/3. 6BK7, 6B7J, 6BQ7, 12/10 ea. 6AC7/1502, 21/4. 6AG7, 21/4. 6C6, 6J5, 9/2 ea. 6H6, 6-9. 6F6, 6L7, 6K6, 12/10 ea. 6SA7 14/-, 6E5, 15/- ea. 6L6, 6SN7, 6SL7, 6SC7, 18/3 ea. 12K8, 14/-, 19B7J, 12B7J, 12A6, 12/10 ea. 12K8, 14/-.

International Octal Bases (Ceramic), 2/6. R.C.A. Button Bases, for 9001, 6AK5, etc. (Ceramic), 1/6. Button Bases with shield cans, 3/-. American Acorn Bases (Ceramic), 2/-. American Loktal Bases (Bakelite), 1/-. EF50 Bases Ceramic or siliconized polystyrene, 3/-.

## TELE-RADIO (1943) LTD.

177, Edgware Road, London, W.2

Telephone : PADdington 6116

PLEASE NOTE: Above is our only address—we are in no way associated with any other company of similar name.

## THIS Does these

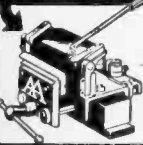

**ACCURATELY and QUICKLY**  
Chassis, Brackets, Shrouds, Condenser and Transformer clips — TREPANING Steel or Aluminium.  
Five sizes—12" to 36"  
Full particulars from:  
**A. A. TOOLS, (W),**  
197a, WHITEacre ROAD  
ASHTON-UNDER-LYNE

**THE COIL PICKUP**  
LOOK FOR IT  
AT THE  
**BRITISH INDUSTRIES FAIR**  
**WILKINS & WRIGHT LTD.,**  
HOLYHEAD RD., BIRMINGHAM, 21

## NEW DUAL TESTOSCOPE

Ideal for high and low voltage testing; 1/30. 100/850 A.C. and D.C. Allowance made on old models. Send for interesting leaflet (R.14) on Electrical and Radio Testing, from all Dealers or direct.

**RUNBAKEN-MANCHESTER**

## LONDEX for RELAYS

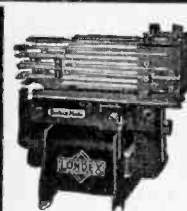

for A.C. and D.C.  
2 VA Coil consumption from 2 to 600 volts and tested to 2000 volts, Aerial Changeover Relays, Mercury Relays, Measuring Relays and Time Delay Relays.

Multiple contact Relay LF. Ask for leaflets RE/WW

**LONDEX LTD**  
MANUFACTURERS OF RELAYS  
207 ANERLEY ROAD LONDON S.E. 20

SYD 6258-9

RESEARCH and development engineer required, sound theoretical knowledge and good mathematical ability an essential; experience of aerial and feeder calculations an advantage; plenty of scope for a man with originality and initiative; laboratory situated in Central London.—State qualifications, experience, and salary required, to Box 7441. [7240]

EXCEPTIONAL opportunities for draughtsmen are afforded by an expansion of the Marconi drawing offices, Chelmsford, for the design of radio equipment; radio experience desirable but not essential, although drawing office experience of electrical and mechanical apparatus definitely required; much of the work is in close collaboration with the research and development engineers.—Apply English Electric Co. Ltd., Queen's House, Kingsway, London, W.C.2. [7213]

DEVELOPMENT engineers, 22-28, with practical experience in electro-acoustic and audio-frequency work wanted for established manufacturer in Guildford-Farnham area; must have had at least three years' industrial experience in similar position, ability to tabulate and analyse results, capable of tracing bibliographically previous developments and of carrying an assignment through from start to finish; write, giving full details of experience, age, etc.; only those applicants complying with the above conditions can be considered; salary commensurate with ability and experience.—Box 6394. [6277]

BRITISH BROADCASTING CORPORATION.—Applications are invited from men (British) for a senior post in the Acoustics Section of Research Department based in London. Applicants should possess a University degree and have a knowledge of physics and electronics; a good knowledge of music is essential as acoustical experimental work in connection with all types of musical combinations will be involved. The duties include research on acoustical design of studios and investigations into the acoustical properties of materials and structures; previous experience in acoustical investigation would be an advantage; commencing salary will be dependent on qualifications and experience, and subject to favourable report will rise by annual increments to a maximum of £890 per annum.—Applications, stating age, qualifications and experience, should reach the Engineering Establishment Officer, Broadcasting House, London, W.1, within fourteen days of the appearance of this advertisement. [7261]

BRITISH BROADCASTING CORPORATION.—Applications are invited from men (British) for a post of engineer in the Design and Installation Department based in London. Applicants must have considerable experience of high quality sound recording systems and a sound knowledge of the electrical and mechanical principles governing their design and operation. It is desirable, but not essential, that candidates should possess a University degree in Electrical Engineering (or equivalent qualifications). The successful applicant will be required to organise and supervise the installation of sound recording equipment of all types at B.B.C. centres throughout the country, and to carry out certain associated technical development work and testing; commencing salary will be dependent on qualifications and experience and subject to favourable reports will rise by annual increments of £30 to a maximum of £680 per annum.—Applications, stating age, qualifications and experience, should reach the Engineering Establishment Officer, Broadcasting House, London, W.1, within fourteen days of the appearance of this advertisement. [7260]

BRITISH BROADCASTING CORPORATION.—Applications are invited for the post of instructor in the engineering training department to cover B.B.C. transmitting stations and studio centres in South-West England; candidates should possess a degree, Higher National Certificate or equivalent qualifications in electrical engineering or physics, and have a good knowledge of radio engineering, experience in teaching and of transmitting and audio frequency apparatus will be an advantage; the successful applicant will be required to undergo a period of training at the Engineering Training Department, Evesham, Wores, and at suitable transmitting and studio centres; the duties will include the training of junior staff, giving specialist lectures, and acting as general liaison officer for training purposes; Commencing salary will be dependent on qualifications and experience and subject to favourable reports will rise by annual increments of £30 to a maximum of £680 per annum.—Applications, stating age, qualifications and experience, should reach the Engineering Establishment Officer, Broadcasting House, London, W.1, within 14 days of the appearance of this advertisement. [7233]

## THESE ARE IN STOCK

Wireless Servicing Manual, by W. T. Cocking, 10s. 6d., postage 5d.  
Radio Engineers Handbook, by F. E. Terman, 35s., postage 9d.  
The Cathode Ray Tube Handbook, by S. K. Lewer, 6s., postage 4d.  
The Wireless World Valve Data, 2s., postage 2d.  
The Radio Tube Vade Mecum, by P. H. Brans, 12s. 6d., postage 6d.  
Radio Engineering, by F. E. Terman, 30s., postage 9d.  
Radio Upkeep and Repairs, by A. T. Witts, 7s. 6d., postage 6d.  
Communication Engineering, by W. L. Everitt, 27s. 6d., postage 9d.  
Problems in Radio Engineering, by E. T. A. Rapson, 5s., postage 4d.  
Thermionic Valve Circuits, by E. Williams, 12s. 6d., postage 6d.  
Standard Handbook for Electrical Engineers, edited by A. E. Knowlton, 45s., postage 1s.  
Radar: Radiolocation Simply Explained, by R. W. Hallows, 7s. 6d., postage 4d.  
WE HAVE THE FINEST STOCK OF BRITISH AND AMERICAN RADIO BOOKS. WRITE OR CALL FOR COMPLETE LIST.  
**THE MODERN BOOK CO.**  
(Dept. W.22), 19-21, Praed St., London, W.2

## A.C.S. RADIO

SPECIALISTS IN AMATEUR AND EXPERIMENTAL SHORT-WAVE EQUIPMENT, Communications Receivers, Television High quality Amplifiers, Speakers, Aerials, Receiving and Transmitting Valves and Meters, etc.  
List "W" free on request to —  
**A.C.S. RADIO, 44, Widmore Rd., BROMLEY, Kent.**  
Phone: RAV 0156

## Beethoven ROTARY CONVERTORS

220 D.C. to 220 A.C.  
Details from:  
**BEEHOVEN ELECTRIC EQUIPMENT LTD.**  
Beethoven Works, Chasco Road, London, N.W.10

## REWINDS

Armatures, Fields, Transformers, Pick-ups, Vacuum Cleaners, Gram Motors, Speakers Refitted New Cones & Speech Coils.  
All Guaranteed and promptly executed, New Vacuum Cleaners, most popular makes. Send stamped addressed envelope for list of Radio Spares, and C.O.D. Service.  
**A.D.S. Co.** 261-3-5, Lichfield Road, ASTON, BIRMINGHAM, 6

## MORSE CODE TRAINING



There are Candler Morse Code Courses for BEGINNERS AND OPERATORS. Send for this Free "BOOK OF FACTS" It gives full details concerning all Courses.

**THE CANDLER SYSTEM CO.,**  
(Room 55W), 121 Kingsway, London, W.C.2  
Candler System Co., Denver, Colorado, U.S.A.



# M. WILSON LTD

## TELEVISION CIRCUIT for the HOME CONSTRUCTOR Model No. 2

Full size blue prints for a 12 valve (including rectifiers) Television Receiver for Home Constructors. This receiver is based on the Unit System of construction and will operate within a 20-mile radius of the Transmitting Station. It uses a Cathode Ray tube of the MAGNETIC DEFLECTION type having a 7-inch screen. The T.R.F. circuit for both Sound and Vision is simple yet efficient.

Unit No. 1. Vision. Unit No. 2. Sound  
Unit No. 3. Time Base. Unit No. 4. Power Pack  
Complete set of 5 blue prints. Full size, including theoretical. Price 10/-

### BLUE PRINTS

Specification of our very successful

### Circuit No. 20

A.C.9 valve Superheterodyne Constructor's Kit receiver 5-2,000 metres. Using our valve sequence, R.F. stage 6K7; 1st detector and Oscillator 6K8; I.F. Amp. 6K7; 2nd detector, A.V.C., 1st L.F. and noise limiter 6B8; Phase inverter H63; Output two 6V6's in Push-pull with negative feedback; Tuning indicator Y63; Full wave rectifier 5U4C. Six wavebands 5-2,000 metres covering Televisions sound. A.V.C. on/off. Controls R.F. gain; Wavechange Switch; A.V.C. on/off. Audio gain control and on/off switch; tone control; radiogram switch. Output 12 watts. Full set of blue prints (Fullsize) 2 PRACTICAL and 1 theoretical with detailed priced list of components 5/- per set. The COIL KIT for above consists of 3, 18 s.w.g. aluminium screens, with 18 iron cored coils and 18 Ceramic trimmers, 2 ceramic padders, 3, two-pole 6-way switches with shorting plates, mounted ready for wiring up from a full size blue print. All A.V.C. resistors and decoupling condensers, fixed padders, screened sleeving, etc., included. Size approx. 5½ x 5½ x 3. Price 25 0 0

**307, HIGH HOLBORN,**  
LONDON W.C.1. Phone: **HOLborn 4631**

## HARTLEY-TURNER HIGHEST FIDELITY SERVICE

We are pleased to welcome the ever-increasing number of technical and musical enthusiasts who come to our new premises to hear good reproduction and exchange views on "hi-fi." Five minutes' demonstration is more convincing than a ton of talk or an acre of advertising. So don't believe a word we say even when we don't say we make the best speaker. Come and hear it and prove it for yourself. And if you can't call, see that you get your name on our mailing list. Otherwise you will miss something good when you most need it. Ask for the speaker leaflet now. Other information will follow automatically.

**SPEAKER: MODEL 215—£9**

**H. A. HARTLEY CO. LTD.**  
152 HAMMERSMITH RD., LONDON, W.6  
TELEPHONE: RIVERSIDE 7387

**BRITISH BROADCASTING CORPORATION**—Applications are invited from men (British) for the post of engineer in the Recording Section of the Research Department based in London. A university degree in Physics or Electrical Engineering (or equivalent qualifications) would be an advantage. Familiarity with low frequency technique is essential and a knowledge of music, sufficient to deal with the "balancing" of the various components of musical combinations for recording purposes, is desirable. Preference will be given to applicants with experience in the design of light electrical and mechanical equipment, and ability to organise development work in the Drawing Office and Workshops. The successful applicant will be employed on research and development work on all aspects of recording and allied low-frequency problems. He will normally work under the supervision of the Head of the Recording Section, but will have ample scope for initiative and originality. Commencing salary will be dependent on qualifications and experience and, subject to favourable report, will rise by annual increments of £370 to a maximum of £680 per annum. Applications, stating age, qualifications and experience, should reach the Engineering Establishment Officer, Broadcasting House, London, W.1. within fourteen days of the appearance of this advertisement. [7285]

### SITUATIONS WANTED

**EXECUTIVE A.M.I.E.E.**, age 35, radar, radio, light electronics, requires change; salary £780.—Box 6393. [6956]

**TECHNICIAN**, 37, 14 yrs. exp. R.F., A.F., P.A., and instr., seeks pos. biological electronics, lab. or dev. preff., good con.—Box 7807. [7344]

**TWO ex-R.A.F.** wireless mechs. seek prog. positions, willing to study, not averse to hard or outdoor work, one employed electrician, other radio fitter.—Box 7749. [7317]

**LECTURER**, public speaker and radio technician, exp. broadcasting, education, science, administration and writing, invites offers of contracts or permanency.—Box 7746. [7346]

**RADIO engineer** (31), wide practical and commercial experience, sales and maintenance, competent business administrator; would travel as representative; available May.—Write Box 7438. [7234]

**QUALIFIED engineer**, 1st class C. & G. Grade III, A.M. Brit. I.R.E., 18 yrs. experience, V.H.F. communications, desires suitable appointment abroad, South Africa, Australia, New Zealand preferred.—Box 7607. [7290]

**SENIOR Radar circuit engineer**, 7 years' Government service on Radar design and development, requires responsible situation, abroad if possible (Radar communications, Geiger counters, etc., industrial electronics), industrial research experience; highest references may be obtained.—Box 7809. [7348]

**WORKS manager**, 44 yrs., with over 16 years' managerial experience, now free for new post; experienced all usual machining and assembly operations for light electro-mechanical assemblies including radio and domestic appliances; used to controlling purchasing, drawing office, toolroom, time study planning costing, budgetary control, maintenance, stores, transport, etc.—Box 7746. [7249]

**WIRELESS engineer**, Dutchman, single, aged 29, awaiting demobilisation, trained Dutch Nautical School and R.A.F. (aircrew wireless operator), sending receiving 18 words min., seeks appointment in England or overseas (e.g. South Africa); willing to serve wherever, by hard work, progress is possible.—J. H. van der Wende, c/o Kerkstraat 2, Musselkanaal (Gr.), Holland. [7253]

### PATENTS.

**THE proprietor of British Patent No. 531963**, entitled "Device for producing vibrato in sound amplifying systems and the like," offers same for licence or otherwise to ensure practical working in Great Britain.—Inquiries to Singer, Ehlers, Stern & Carlberg, 28, East Jackson Boulevard, Chicago, 4, Illinois, U.S.A.

### TUTION

**RADIO training**—P.M.G. exams, and I.E.E. Diploma; prospectus free.—Technical College, Hull. [0611]

**RADIO Engineering**, Television and Wireless Telegraphy, comprehensive postal courses of instruction.—Apply British School of Telegraphy, Ltd., 179, Clapham Rd., London, S.W.9 (Est. 1906.) Also instruction at school in wireless for H.M. Merchant Navy and R.A.F. [9249]

### BOOKS, INSTRUCTIONS, ETC.

**FEW technical radio books**, ball price; stamp list.—Dawson, 59, Alfred St., Gloucester. **WEBB'S radio map of the world** locates any station heard, size 40x30in., 4/6, post 6d.; on linen, 10/6, post free.—Webb's Radio, 14, Soho St., W.1. Gerrard 2089. [9947]



Show them the  
**'PLANET'**  
A Brilliant  
performer

## AN AC/DC five valve Superhet Two Wave- Band Receiver for 200-250 volt mains...

Of striking appearance in attractive two-colour plastic cabinet, with unique illuminated translucent dial and novel tuning mechanism to combine slow and accurate tuning with fast band search (5 tuned circuits).

**SPECIFICATION:**  
Specially built-in "Hemosec" aerial... Manufactured for the Home Market in Medium Wave Band 200/550 metres and Long Wave Band 800/2,000 metres. Also for Export in Medium and Short Wave Bands 16/49 metres.

**£13.13.0** Plus Purchase Tax  
£3.38.

In maroon, red, white or pastel shades of blue, pink, green, 7s. extra. Plus 1/9 P. Tax. **Guaranteed.**  
**CHAMPION ELECTRIC CORPORATION**  
CHAMPION WORKS, SEAFORD, SUSSEX  
Tel. No.: SEAFord 3235

## REWINDS

Send your "Burn outs" to be Rewound — no technical data wanted. Post Transformer, etc., labelled with your name and address marked "for Rewind."

**OUR WINDINGS ARE  
LAYER WOUND & IMPREGNATED**

**SOUTHERN TRADE SERVICES, LTD.**  
297/299, HIGH ST., CROYDON

Tel.: 4870

Manufacturers of "TELECRAFT" PRODUCTS

## POST-WAR TELEVISION

The advance in Radio Technique offers unlimited opportunities of high pay and secure posts for those Radio Engineers who have had the foresight to become technically qualified. How you can do this quickly and easily in your spare time is fully explained in our unique handbook.

Full details are given of A.M.I.E.E., A.M.Brit.I.R.E. City & Guilds Exams., and particulars of up-to-date courses in Wireless Engineering, Radio Servicing, Short Waves, Television, Mathematics, etc., etc.

**We Guarantee "NO PASS—NO FEE"**

Prepare for to-morrow's opportunities and post-war competition by sending for your copy of this very informative 112-page guide NOW—FREE.

**BRITISH INSTITUTE OF ENGINEERING TECHNOLOGY (Dept. 388)**

17, Stratford Place, London, W.1

**MIDLAND INSTRUMENT CO.**  
**SPECIAL OFFER OF EX-GOV. ALL-DRY BATTERIES**  
 Highest grade manufacture, tropical standard, in airtight packing, brand new and fully guaranteed by us, 90-v. H.T. plus 1½-v. L.T. 5½, post 8d. Sealed cartons of 8, 35/-, post paid. Trade supplied. Above can easily be split to form three 30-v. H.T. units (size of U.2 cell), ideal for midget sets, deaf aids, etc. Hundreds of other items: send for our new March Lists, 2d., with a.s.e.  
 18, Harborne Park Road, Birmingham. 17.  
 Tel.: HARborne 1308.

**Aladdin**  
**RADIO CORES**  
*for all purposes*  
**GREENFORD, MIDDx. WAXLOW 2300**

## LIMITED SUPPLIES ONLY

*Deposit will secure*

Canadian 103 Sets. Ideal for 6 volt Car or Yacht Radio. Coverage 200-550 metres plus 2 Short Wave Bands. Complete with Aerial and Leads..... **25 Gns.**  
 EDDYSTONE 540X Communications Receiver ..... **£58 18 6**  
 B.P.L. Signal Generator. A.C. 100 K/cs to 20 M/cs ..... **20 Gns.**  
 Avo, Model 7 ..... **£19 10 0**  
 and an exceptionally fine range of components and valves. 1/- P.O. will bring you our new revised catalogue.

**B:I:S**

63, London Road, Brighton 1, Sussex.

Tel.: Brighton 1555.



*Products of Quality & Reliability*

**MAINS TRANSFORMERS**  
**A. F. TRANSFORMERS**  
**SMOOTHING CHOKES**  
**THERMAL DELAY SWITCHES**  
**POWER RESISTANCES**

*Made by*

**OLIVER PELL CONTROL LTD**

Telephone - WOOLWICH 1422  
 CAMBRIDGE ROW · WOOLWICH S·E·18

## AN EXTENSIVE RANGE OF HIGH GRADE TRANSFORMERS

- MAINS TRANSFORMERS 60 and 100 watt, 350-0-350v, 0-4-5v, 0-4-6.3v. Totally enclosed in Metal Shell.
- UNIVERSAL OUTPUT TRANSFORMERS. Suitable for Triode, Pentode, Class B and Q.P.R. Output Stages Fully Tropicalised.
- PRECISION TRANSFORMERS AND CHOKES (LAB RANGE.) Transformers and chokes in this range are precision built components with a guaranteed tolerance of 2% of rated values. First Grade Material; only are used in their manufacture. Lab range components can be made to individual specifications or supplied from our comprehensive Catalogue.



Cables: SIMSALE, LONDON

Telegrams: SIMSALE, WESDO, LONDON.

**RECORDER HOUSE,**  
 48-50, GEORGE STREET,  
 PORTMAN SQUARE,  
 LONDON, W.1

## SIFAM RADIO SERVICING D.C. TEST SET Type R.T.10.

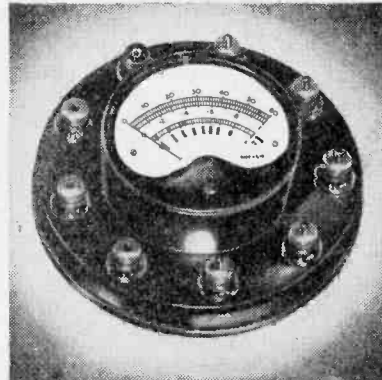

Designed with the latest movement this 3½" simplified test set has clear scale reading and 12 D.C. ranges: 100 mV (with ext. shunts) 2, 6, 120 and 300 volts, 1, 6, 600 mA, 6 amperes, 50,000 ohms, with 2000 at centre.  
**PRICE £6 0 0**

- 12 D.C. ranges
- No switches to go wrong
- Long clear scales
- Positive push button selection
- Easily serviced
- Designed to stand heavy overloads
- Accurate in any position
- 1000 Ω per volt

*22 years Specialised Experience*

**SIFAM ELECTRICAL INSTRUMENT CO. LTD., TORQUAY, DEVON**

**Superspeed**  
**SPECIAL**

**CORED SOLDER**

**A.I.D. APPROVED**

**H. J. ENTHOVEN & SONS LTD.**  
 230 THORNTON ROAD, WEST CROYDON, SURREY  
 THORNTON Heath 2462



# STABILITY

*and  
accuracy*

Of unfeeling interest to visitors to the Royal Observatory is the historical plate let into the outer wall, carrying the pegs which give the master measurement of the British Yard.

**T**HE familiar buildings of the Royal Observatory house a proud and stable tradition of British scientific accuracy . . . "Greenwich Time" is never questioned.

Where stability, accuracy of capacitance are essential requirements, Hunts Silvered Mica Capacitors can be relied upon. They also possess the advantages of initial low cost

and also economical application, the lightweight construction allowing them to be used without fixing holes or special mountings.

A range from 10 to 10,000 pF is available in a variety of types and sizes — full details upon request.

**HUNTS**  
**CAPACITORS**

TRADE MARK,

**PROTECTED  
SILVERED MICA**

A. H. HUNT LTD. LONDON, S.W.18  
Established 1901

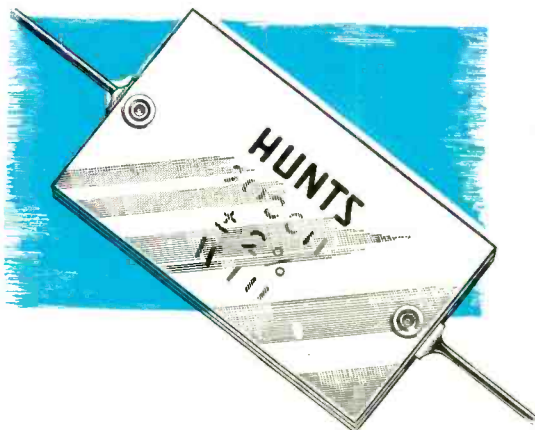

## WHY ERSIN MULTICORE SOLDER GIVES YOU *High Speed* **PRECISION** **SOLDERING**



SIZE 7 REELS  
for Factory use.



SIZE 1 CARTONS  
for Service Engineers and  
Workshops.

Used with the correct soldering technique, Ersin Multicore Solder gives you guaranteed sound joints with high speed precision production. The secret is in the Ersin Flux (exclusive to Multicore) combined with the three core construction. Ersin is a high grade rosin which has been specially processed to increase its fluxing action without impairing its well-known non-corrosive properties. Three cores of flux in Ersin Multicore ensure rapid melting and flux continuity, thus speeding up soldering operations and eliminating waste. Correct proportions of flux to solder are maintained, and there is always a supply of flux available for the next joint.

### PRICES SIZE 1 CARTONS

Catalogue Ref. No.	Alloy Tin/Lead	S.W.G.	Approx. length per carton	List price per carton (subject)
C 16014	60/40	14	44 feet	s. d. 6 0
C 16018	60/40	18	114 feet	6 9
C 14013	40/60	13	27 feet	4 10
C 14016	40/60	16	60 feet	5 3

In case of difficulty write to :

**MULTICORE SOLDERS LIMITED**

MELLIER HOUSE, ALBEMARLE STREET, LONDON, W.1. Tel.: REGent 1411